

# The Hemblens of Bath and beyond

An overview of the descendants of Isaac Hemblen who lived in  
Bath, Somerset, England in the early 1800s

Isaac Hemblen of this Parish  
Widower  
and Elizabeth Fox of this Parish  
Spinsters  
were married in this Church by Bennet with Consent of  
this twelfth Day of  
August in the Year One thousand eight hundred and thirty-two  
By me William L. Nichols, Curate  
This Marriage was solemnized between us { The said Isaac Hemblen  
Elizabeth Fox  
In the Presence of { The said Thomas Fox  
Benjamin Fox  
No. 494.

James J. Cosgrave

First published 2021 by  
James J. Cosgrave  
Parksville, British Columbia, Canada

First edition: Mar 2021

Second edition: Jun 2022

Third edition: Sep 2022

Fourth edition: Oct 2024

This publication may be freely reproduced, stored or transmitted in any form or by any means, for non-commercial purposes. Except as permitted under Canadian copyright law, this publication may otherwise only be reproduced, stored or transmitted in any form or by any means, with the prior permission in writing of the publisher.

A later version of this document may be available for download at [www.treesandgenes.com](http://www.treesandgenes.com)

Feedback and suggestions are welcome and should be sent to [info at treesandgenes.com](mailto:info@treesandgenes.com)

Front cover: Bedminster, Somerset marriage registration of Isaac Hemblen and Elizabeth Rose.

© 2021 - 2024 James J. Cosgrave

## Table of Contents

Introduction .....	4
Chapter 1 – Isaac Hemblen .....	6
Chapter 2 – Mary Anne Hemblen & Arthur Brinkworth.....	9
Chapter 3 – Elizabeth Hemblen & James Elder .....	11
Chapter 4 – Elizabeth Hemblen and John Meale .....	14
Chapter 5 – Emma Hemblen (1834 - 1895) .....	16
Chapter 6 - Jane Hemblen and William Stainer Coffin .....	18
Chapter 7 – Elizabeth Hemblen and William Thomas .....	23
Chapter 8 – Ellen Meale and James Alexander Cosgrave.....	26
Chapter 9 – Joseph Meale and Catherine Margaret Logue .....	32
Chapter 10 – George Meale and Edith Mary Faithfull .....	34
Chapter 11 – Elizabeth Meale and Thomas Kelly .....	39
Chapter 12 – Vivian John Cosgrave and Justine Brady .....	43
Chapter 13 – George Edward Cosgrave .....	46
Chapter 14 – James Steele Cosgrave (jnr.).....	48
Chapter 15 – James Edward Cosgrave and Kathleen Veronica Sherlock .....	50
Chapter 16 – George Steele Cosgrave .....	55
Chapter 17 – DNA Testing .....	57
References.....	59

## Introduction

Researching my Hemblen ancestry has been no easy task, as there has not been a clear path back through the generations. I have relied on letters written by long-dead relatives to identify how my Hemblen ancestors made the leap from the City of Bath in Somerset, England, to Tasmania in Australia, and eventually to New Zealand.

Nevertheless, I believe that the family relationships identified in this document are accurate, and that belief is supported by autosomal DNA evidence, which will be discussed in more detail in the final chapter of the document.

This document is intended to provide a general overview of the many descendant branches of our Hemblen family tree. There will be more information on my immediate family, and their story, as that is what I am most familiar with, but I hope that it will also provide a better understanding of the other descendant lines, and how we are all related.

Throughout the document, to protect their privacy, I have tried to avoid providing details of living relatives, and I apologize if this cut-off has not been perfectly executed.

This is not intended to be the final word on the Hemblen family of Bath, and I hope that over time, new information will be identified, and that people from the various descendant branches might add additional chapters to this document, expanding the story of their Hemblen lines.

This document would not be possible without the wealth of information shared with me by other descendants of Isaac Hemblen, especially Murray Sallen, for which I am most grateful.

I apologise for any errors that may have crept into the document, and I welcome any corrections, family photographs, or other feedback.

The chart on the next page shows with yellow highlight the ancestral line that is the focus of this document.

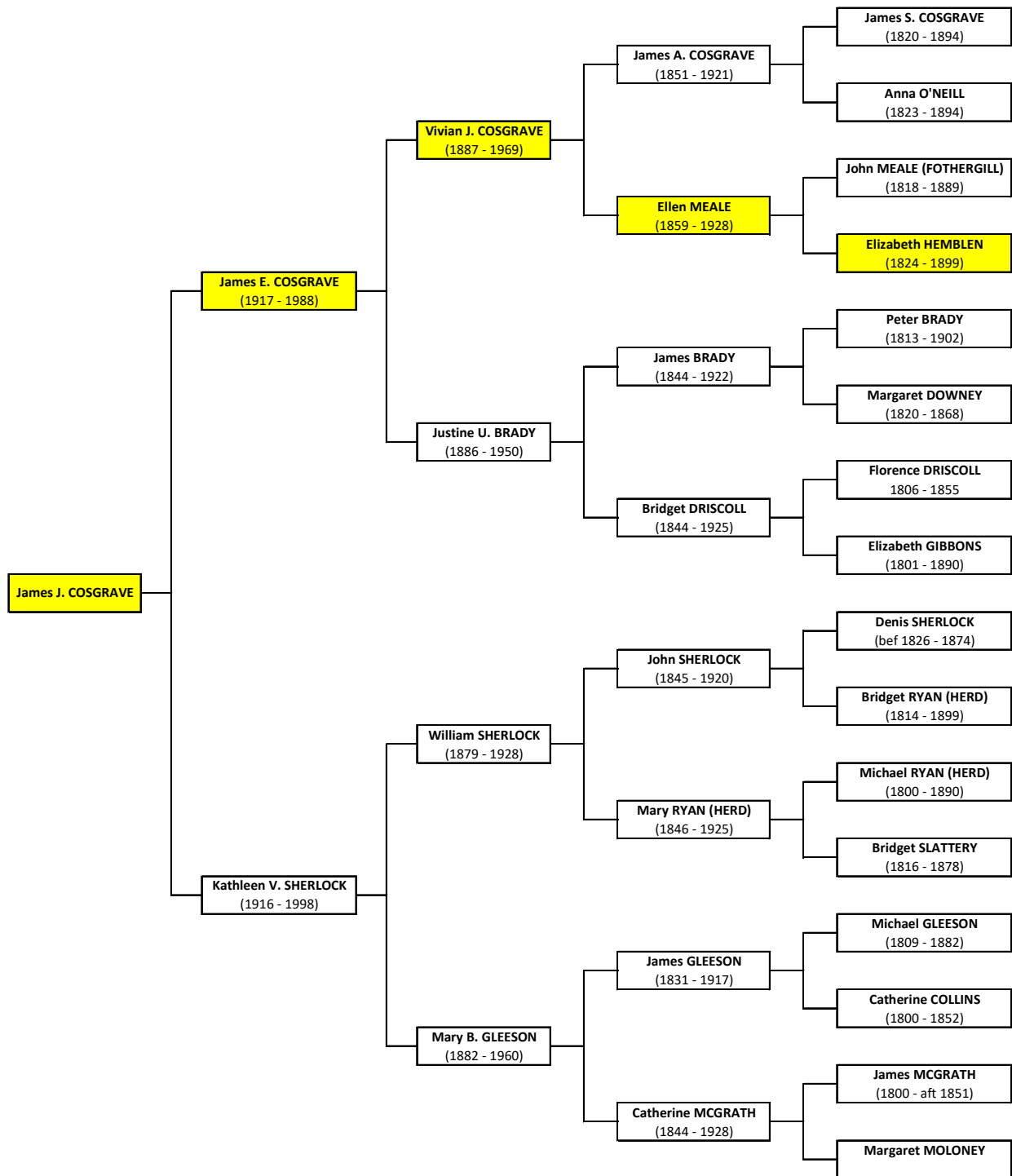

## Chapter 1 – Isaac Hemblen

My earliest confirmed Hemblen ancestor is Isaac Hemblen, a stone mason by trade, who was born circa 1791. The 1851 census of Bath<sup>i</sup>, identifies that the 60 year old Isaac was living at 62 Avon Street, with his wife and several children, and states that he was born at Dyrham, Gloucestershire.

A search of the Dyrham and Hinton parish records does not identify a baptismal entry for an Isaac Hemblen around 1791. There is however an Isaac Emley, son of Samuel and Jane Emley, baptised 6 January 1792 -

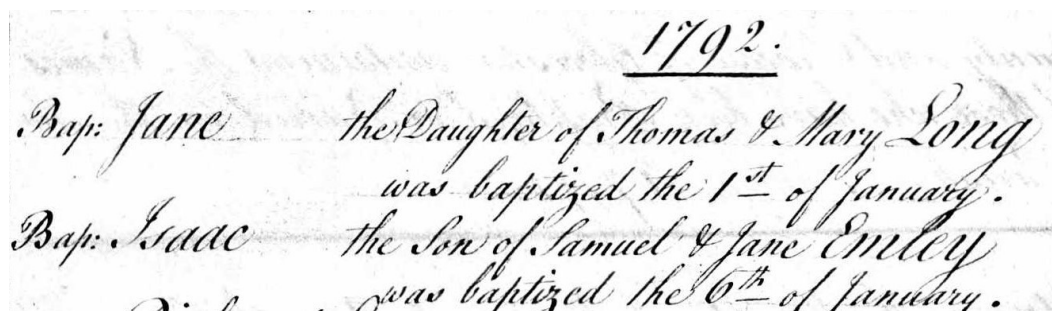

1792.  
Bap: Jane the Daughter of Thomas & Mary Long  
was baptized the 1<sup>st</sup> of January.  
Bap: Isaac the Son of Samuel & Jane Emley  
was baptized the 6<sup>th</sup> of January.

### Possible baptism of Isaac Hemblen

Could this be our Isaac? I have encountered the family surname spelled in a variety of ways, and Emley and Hemblin sound very similar when you drop the H. But it is also possible that Isaac was baptised in a non-conformist religion for which a record has not been found. This is the research brick wall that has prevented the identification of earlier generations of Hemblens.

Isaac Hemblen is known to have married twice. Isaac married his first wife, Mary (maiden surname unknown), circa 1815, and the marriage produced four children as follows –

- Mary Anne Hemblen, born circa 1816-1819
- James Hemblen, baptised 3 September 1820
- Sarah Hemblen, baptised 31 March 1822
- Elizabeth Hemblen, born circa 1824

Mary Anne Hemblen appears in the 1841 census<sup>ii</sup> as a 25 year old, and no further record of her was found until 2024 when a descendant of Mary Anne was identified as an Ancestry DNA match to me. This discovery and her family will be covered in more detail in chapter two.

Isaac Hemblen	50		Mason	4
Elizabeth Do.		35		4
Mary Do.		25		4
Sarah Do.		18		4
Elizabeth Do.		15		4
John Do.		9		4
Emma Do.		7		4
Jane Do.		6		4

Isaac Hemblen & family in 1841 census.

James Hemblen lived for only five months and was buried on 4 February 1821.

Sarah Hemblen was convicted of stealing a pair of stays in December 1842, and sentenced to six months hard labour. No further record has been found of her.

Elizabeth Hemblen (my great great grandmother) will be covered in detail in chapter three and chapter four of this document.

Mary, the first wife of Isaac Hemblen, is presumed to have died between 1824 and 1832, as on 12 August 1832, Isaac married Elizabeth Rose (see cover photo), and they had four children together, as follows –

- John Hemblen, baptised 12 November 1832
- Emma Hemblen, baptised 9 September 1834
- Jane Hemblen, born 31 August 1838
- Elizabeth Hemblen, born 9 November 1842

Isaac Hemblen	Head	Mar	50	Mason	Gloucester (Duckham)
Elizabeth Do.	Wife	Mar	34	Do	Bath
John Do.	Son	U	17	Labr	Do
Emma Do.	Daughter		15		Do
Jane Do.	Daughter		14	Scholar	Do
Elizabeth Do.	Daughter		9	"	Do

Isaac Hemblen & family in the 1851 census.

John Hemblen married and had three sons. To date I have found no record of the eldest son beyond his birth, and the other two sons died young. Details are as follows –

1. John HEMBLEN (b.1832-Somerset, England; d. Apr/Jun 1886-Bristol, Gloucester, England)  
sp: Martha DODD (b. Jul/Sep 1857-Bath, Somerset, England; m.17 Feb 1875; d. Oct/Dec 1925-Bristol, Gloucester, England)
  2. William John HEMBLEN (b. Apr/Jun 1876-Bath, Somerset, England)
  2. Isaac HEMBLEN (b. Jan/Mar 1879-Barton Regis, Gloucester, England; d. 20 Oct 1880-Bristol, Gloucester, England)
  2. Alfred HEMBLEN (b. 26 Dec 1882-Barton Regis, Gloucester, England; d. Apr/Jun 1883-Barton Regis, Gloucester, England)

The three daughters of Isaac Hemblen’s second marriage all married and had children themselves. Their lives will be covered in later chapters.

The Bath Chronicle newspaper of 25 November 1858<sup>iii</sup> reported that Isaac Hemblen had suffered an accident, as follows – “*ACCIDENT – On Saturday afternoon, a mason, named Isaac Hemblen, slipped down at Widcombe and broke his left leg; he was promptly removed to the United Hospital, where the fracture was found to be of such a serious character as to render amputation necessary. The operation was speedily and successfully performed, but the sufferer remains in a dangerous state.*”

The operation may have been a success, but Isaac died on 3 December 1858, just a week after the surgery. His second wife, Elizabeth, lived only four months after Isaac’s death, dying of pleurisy on 8 April 1859.

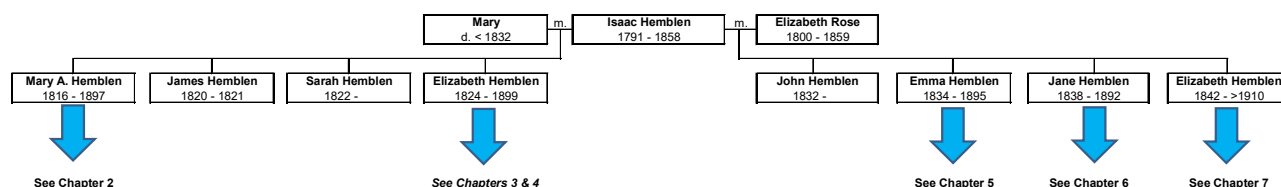



## Chapter 2 – Mary Anne Hemblen & Arthur Brinkworth

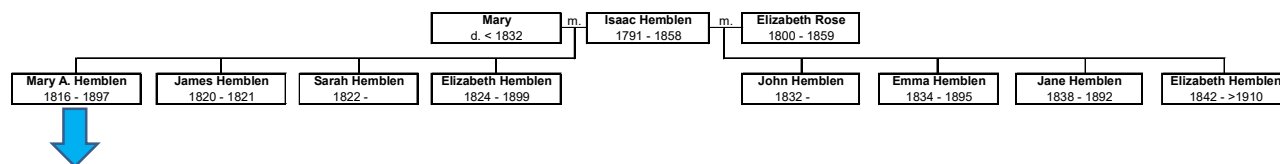

Mary Anne Hemblen, the eldest child of Isaac and Mary Hemblen, was living at home in the 1841 census, but is not listed with the family in the 1851 census.

As described in chapter 17, autosomal DNA evidence suggests that Mary Anne Hemblen is the 25-year-old Mary Emblym who married Arthur Brinkworth on 25 March 1844 at St. Gluvias, Cornwall<sup>iv</sup>.

Mary Anne and Arthur Brinkworth appear to have had only one child, Sarah, who was born in 1854 at Lambourn, Berkshire, per the 1861 census. Sarah's birth registration states that her mother's maiden surname is Amblin.

The family moved to the Isle of Wight, and it was here in 1876 that Sarah Brinkworth married Patrick Moylan, and that Mary Anne and Arthur Brinkworth died. Arthur died in 1882 and Mary Anne died in 1897. Their known descendants are as follows -

1. Mary Anne HEMBLEN (b. Abt 1819-Bath, Somerset, England; d. Oct/Dec 1897-Isle of Wight, Hampshire, England)
  - sp: Arthur BRINKWORTH (b. Abt 1812-Horsley, Gloucester, England; m. 25 Mar 1844; d. Jan/Mar 1882-Isle of Wight, Hampshire, England)
2. Sarah BRINKWORTH (b. Apr/Jun 1854-Lambourn, Berkshire, England; d. Jul/Sep 1926-Isle of Wight, Hampshire, England)
  - sp: Patrick MOYLAN (b. Abt 1852-Preston, Lancashire, England; m. Oct/Dec 1876; d. Jul/Sep 1926-Isle of Wight, Hampshire, England)
3. Arthur Patrick MOYLAN (b. Apr/Jun 1877-Newport, Isle of Wight, England; d. Oct/Dec 1945-Winchester, Hampshire, England)
  - sp: Elizabeth ROGERS (b. Abt 1868-Winchester, Hampshire, England; m. Jul/Sep 1903; d. Jan/Mar 1950-Winchester, Hampshire, England)
4. Arthur Frederick MOYLAN (b. Abt 1903-Winchester, Hampshire, England; d. 14 Nov 1956-Tauranga, New Zealand)
  - sp: Susan May LAW (b. 18 May 1908-Derby, Derby, England; m. 1936; d. 20 Nov 2001-New Zealand)
3. Francis MOYLAN (b. Abt 1880-Aldershot, Hampshire, England; d. Jan/Mar 1963-Isle of Wight, Hampshire, England)
3. Hugh MOYLAN (b. 29 Apr 1883-Kildare, Ireland; d. Oct/Dec 1951-Isle of Wight, Hampshire, England)
3. Sarah Ann MOYLAN (b. Jan/Mar 1885-Newport, Isle of Wight, England; d. Jan/Mar 1940-Isle of Wight, Hampshire, England)
  - sp: William CHESSELL (b. 19 Jul 1882-Newport, Isle of Wight, England; m. Jul/Sep 1904; d. Apr/Jun 1976-Isle of Wight, Hampshire, England)

4. William Arthur CHESSELL (b. Oct/Dec 1904-Newport, Isle of Wight, England; d. Oct/Dec 1974-Isle of Wight, Hampshire, England)  
 sp: Ivy May SIVIER
5. William G. CHESSELL (b.3 Mar 1939-Cowes, Isle of Wight, England; d. 29 Sep 2008-Rainham, Essex, England)  
 sp: LOWE
4. Frank CHESSELL (b. Jul/Sep 1907-Cowes, Isle of Wight, England; d. Aft 1910)
4. Albert CHESSELL (b. Oct/Dec 1909-Horsebridge Hill, Isle of Wight, Hampshire, England; d. Aft 1910)
3. Alice Maud MOYLAN (b. Jul/Sep 1887-Newport, Isle of Wight, England; d. Jan/Mar 1958-Isle of Wight, Hampshire, England)  
 sp: Frederick Truckle BLOW (b. Abt 1886-Newport, Isle of Wight, England; m. Jan/Mar 1906; d. Apr/Jun 1947-Isle of Wight, Hampshire, England)
4. Frederick William BLOW (b. Abt 1908-Newport, Isle of Wight, England; d. Aft 1910)
4. Violet BLOW (b. Abt 1909-Newport, Isle of Wight, England; d. Aft 1910)
4. Phyllis F. BLOW (b. Oct/Dec 1913-Isle of Wight, Hampshire, England)
4. Charles T. BLOW (b. Jul/Sep 1916-Isle of Wight, Hampshire, England)  
 sp: Lily K. COOMBES (m. Jan/Mar 1937)
4. Raymond A.T. BLOW (b. Jul/Sep 1921-Isle of Wight, Hampshire, England)
4. Norman S. BLOW (b. Apr/Jun 1924-Isle of Wight, Hampshire, England)
4. Alan D. BLOW (b. Jul/Sep 1927-Isle of Wight, Hampshire, England)
3. Rosina MOYLAN (b. Jan/Mar 1890-Newport, Isle of Wight, Hampshire, England; d. Jan/Mar 1963-Isle of Wight, Hampshire, England)
3. Mary Ann MOYLAN (b. Jul/Sep 1892-Newport, Isle of Wight, Hampshire, England; d. Oct/Dec 1933-West Ham, Essex, England)  
 sp: George Charles HOWARD (b. Apr/Jun 1892-St Saviour, Southwark, London, England; m. Apr/Jun 1926)
4. Charles L. HOWARD (b. Oct/Dec 1926-West Ham, Essex, England)
4. William A. HOWARD (b. Jan/Mar 1929-West Ham, Essex, England)
4. John P. HOWARD (b. Jul/Sep 1931-West Ham, Essex, England; d.2007-Southampton, Hampshire, England)  
 sp: Ruth PALMER (b. 20 Jun 1930-Bournemouth, Hampshire, England; m. Oct/Dec 1957; d.1977-Southampton, Hampshire, England)
4. Raymond M. HOWARD (b. Jan/Mar 1934-West Ham, Essex, England)
3. John William MOYLAN (b. Jan/Mar 1896-Newport, Isle of Wight, Hampshire, England; d. 30 Sep 1917-Mesopotamia)

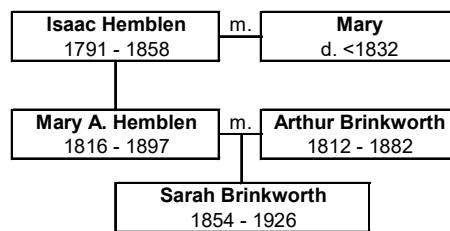

## Chapter 3 – Elizabeth Hemblen & James Elder

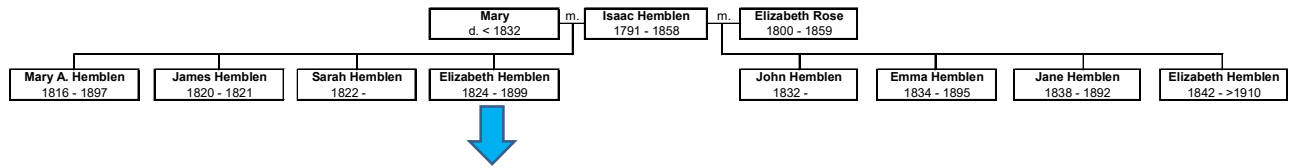

Family stories passed down through the generations suggest that Elizabeth Hemblen was not treated well by her step-mother, and Elizabeth rebelled. On 11 October 1841, 16 year old Elizabeth Emblin appeared before a judge at the Bath City Sessions, charged with larceny, for stealing a pair of boots. She was convicted and sentenced to one month in prison.

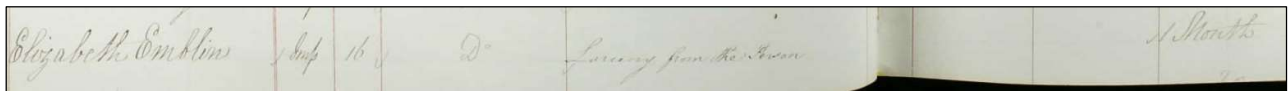

Elizabeth Hemblen criminal sentence – October 1841.

Elizabeth obviously fell in with bad company, as soon after her release from prison, she appeared before a judge at the Bath City Sessions on 29 December 1841, along with Mary Ann Elmes and Elizabeth Stokes, charged with stealing a frying pan worth 12 pence, property of William Pullen, on 20 November 1841. As all three of the accused had previous convictions, they were each sentenced to 7 years transportation.

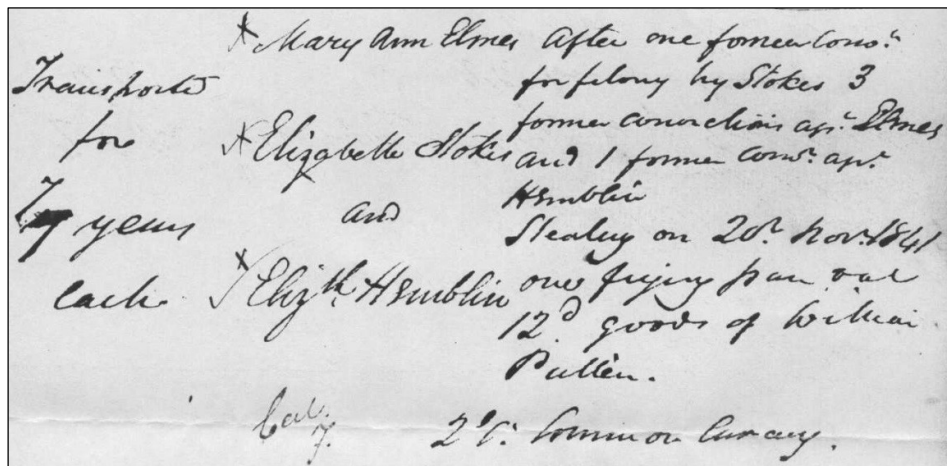

Elizabeth Hemblen criminal register – December 1841.

On 2 May 1842, Elizabeth Hemblen, Mary Ann Elmes, Elizabeth Stokes and 200 other convicted women departed England on the ship *Royal Admiral*, bound for Van Diemen's Land (Tasmania). The *Royal Admiral* was a 414 ton, three-masted barque, built at King's Lynn in 1828, and this was her fourth convict voyage. The water casks on board were very leaky, requiring the ship to stop at the Cape of Good Hope (Cape Town) to take on fresh water, which lengthened the voyage. By the time the ship arrived at Hobart, on 24 September, 145 days after leaving England, two of the passengers had died.

At this time the Cascades Female Factory in Hobart was full, already housing more than 700 female convicts and their children, so on 8 October 1842, Elizabeth Hemblen, and many of the other women from the *Royal Admiral*, were transferred to the ship *Lady Franklin*, for the journey

to Launceston, on the north side of the island. On arrival in Launceston, the women and children were transferred to the Launceston Female Factory, which had been designed to house 100 inmates, but with the addition of the women and children from the *Royal Admiral*, it soon housed 278 women and 43 children<sup>v</sup>.

NAME,	<i>Hemblen Eliz</i>	No.
Trade .....	<i>As Maid</i>	
Height (without shoes)....	<i>5' 3/4"</i>	
Age .....	<i>21</i>	
Complexion .....	<i>Ruddy</i>	
Head .....	<i>Large</i>	
Hair .....	<i>Light Brown</i>	
Whiskers .....	<i>Brown</i>	
Visage .....	<i>Broad</i>	
Forehead .....	<i>Broad Low</i>	
Eyebrows .....	<i>Dark Brown</i>	
Eyes .....	<i>Hazel</i>	
Nose .....	<i>turned up large nostrils</i>	
Mouth .....	<i>Medium</i>	
Chin .....	<i>Broad</i>	
Remarks .....	<i>L. Dots E F J C J F J R</i>	

Elizabeth Hemblen description.

The Australian convict records provide invaluable information about each convict.

The Convict Description<sup>vi</sup> for Elizabeth tells us that she was a little over 5 feet tall, with a ruddy complexion, large head, light brown hair, hazel eyes, a broad chin, upturned nose with large nostrils, and a broad low forehead. She was a housemaid by trade.

Elizabeth also had a tattoo on her right arm, consisting of 7 dots and the letters E, F, J C, J F, J R and H N. Lucy Williams<sup>vii</sup> suggests that the initials may commemorate loved ones or her criminal history. Perhaps the 7 dots represented her sentence? We will likely never know what this tattoo represents, but it is amazing, 180 years later, to even know that she had a tattoo.

Her Indent record<sup>viii</sup> identifies that she can read and can write a little, that she left a father named Isaac, one brother named John, and four sisters – Sarah, Mary Ann, Jane and Emma, at her native place. Her character on board ship was described as “Good”. At that time Elizabeth would have been unaware of her half-sister, another Elizabeth, as she was born a few months after Elizabeth arrived in Tasmania.

The female convicts were assigned to free settlers, to whom they provided work, in return for food and clothing. We have no record of who Elizabeth was assigned to work for, but it was perhaps James Elder, as on 10 January 1844, the already pregnant Elizabeth requested permission to marry James Elder.

Elizabeth Hemblen married James Elder on 11 March 1844<sup>ix</sup> at the parish church (Church of England) in Evandale, a few miles outside of Launceston. Elizabeth is described as a 21 year old assisted servant, and James is described as a 33 year old free settler, although he may have been closer to 39 years old. It is likely, but not certain, that James Elder was transported on the ship *Phoenix* which arrived in Tasmania on 21 July 1824, at which time he is described as a 19 year old Plasterer from Glasgow. He would have served his sentence by 1831, hence was “free” at the time of his marriage to Elizabeth Hemblen.

Marriage did not mean that Elizabeth didn’t have to serve the balance of her sentence. She was still obliged to attend the regular convict musters to show that she had not absconded, and the authorities were probably relieved that she now had a husband to be responsible for her.

Their first child, whom they named Elizabeth, was born 1 July 1844, and the birth was registered in the Bothwell district. James Elder, Plasterer of Black Marsh is listed as the

informant on the birth registration. No further record has been found of this child, but it is believed that she died in Tasmania before 1852.

With good behaviour, Elizabeth Elder (nee Hemblen) was granted a Ticket of Leave in February 1845, and the family moved south to Hobart. Seventeen months later, on 9 July 1846, Elizabeth gave birth to her second child, James Elder, in Hobart. James lived into adulthood and will be discussed further in the next chapter.

Elizabeth received a conditional pardon in July 1848, having spent four years and seven months in the colony and having completed five and a quarter years of her seven year sentence, without having once being charged with misconduct. She became free on 29 December, 1848, having completed her seven year sentence.

On 14 April 1849, Elizabeth's husband, James Elder, died in Hobart, from inflammation of the brain. On his death registration he is described as a 44 year old Plasterer, and the informant is Elizabeth Elder, of Murray Street, his wife. Just a month after James' death, on 14 May 1849, Elizabeth was officially granted her Certificate of Freedom.

At the age of 25 years, Elizabeth Elder, nee Hemblen, a widow with a three year old son, was now free to leave Tasmania, and she could return to England if she wished. Her later life will be explored in chapter four.

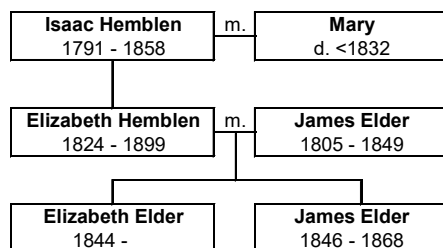

## Chapter 4 – Elizabeth Hemblen and John Meale

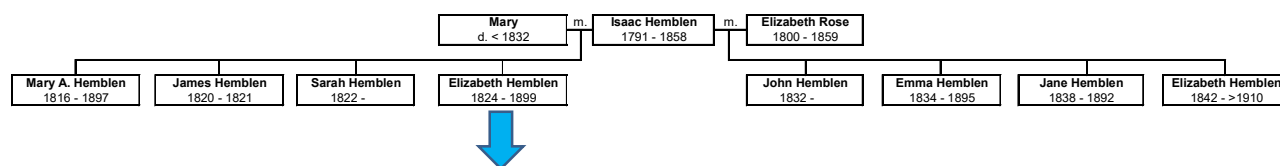

In the early 1850s Elizabeth Elder (nee Hemblen) met John Fothergill, a fellow convict in Tasmania. John Fothergill did not yet have his freedom, and was known to have a wife and family back in Yorkshire, England, so he could not marry Elizabeth Hemblen, and could not leave Tasmania. But it seems that John Fothergill, Elizabeth Hemblen, and her young son, James Elder, somehow boarded a ship and travelled to New Zealand, where John assumed the name John Meale. Their New Zealand descendants all carried the Meale surname.

On 13 June 1854, Elizabeth Hemblen and John Meale were married in St. Patrick's Roman Catholic Cathedral in Auckland, New Zealand. The civil marriage record identifies Elizabeth Hemlin as a 28 year old spinster, and John Mele as a 33 year old bachelor, occupation Boatman, with both residing at Auckland. The church marriage record identifies both the bride and groom as being from England, now of Auckland, with Elizabeth's parents being Isaac and Elizabeth Hemlin and John's parents being Samuel and Elizabeth Mele.

Elizabeth and John Meale produced five children as follows –

- John James Meale, born 2 June 1855 at Auckland
- Ellen Meale, born 3 July 1859 at Waiwera
- Joseph Meale, born May 1861 at Waiwera
- George Meale, born 7 May 1863 at Waiwera
- Elizabeth Meale, born 19 March at Waiwera

Soon after the birth of their first child, John and Elizabeth moved to Waiwera, where they farmed for the remainder of their lives.

Elizabeth's son, James Elder (who was known as James Meale), a Labourer by occupation, died of tuberculosis at the Provincial Hospital on 22 January 1868, at the age of 21 years.

John James Meale died 19 June 1870, at the age of 15 years, as a result of a shooting accident whilst playing with friends. The New Zealand Herald<sup>x</sup> reported the incident as follows – *"FATAL GUN ACCIDENT AT WAIWERA.-INQUEST. [from our own correspondent.] The Waiwera has been the most unfortunate place, I think, in the whole northern portion of this province during the last six months. Out of a population not exceeding thirty people, accidental deaths have amounted to four since elections in December. On the night of the elections three were drowned coming from the poll. Now I have to record another death, caused through incautious use of firearms, and entrusting boys with guns. On Sunday last four boys started from Mr. Meal's for a day's amusement into the bush, having one gun with them. On their way home, and within a quarter of a mile of Mr. Meal's house, they commenced amusing themselves by jumping over a large rata log. Young Meal, to whom the gun belonged, leaving this weapon resting against the log with the hammer down, and continued occupying himself along with the other three, until apparently it was time to think about going home; then he stood upon the top of the log, and*



reaching over, seized the gun by the barrel, and, in drawing it towards him the hammer must have caught in something, or might have struck against the tree. However, it went off, and the charge of shot entering his right side caused almost instantaneous death, for the poor fellow only spoke twice, 'Bob, I'm shot,' each time, and staggered from the log, expiring within four or five paces from where he received his fatal wound. The following depositions were taken at the inquest, before Mr. Lloyd (coroner), and a jury of twelve, Mr. McCattie being foreman:— Robert Lewill deposed: I was with John Meal yesterday when he shot himself, Meal and the rest of us were jumping over a log. Meal lifted the gun, and as he lifted the gun it went off. Hammer was lying on the cap. He lifted the gun up holding it by the barrel. He was on the opposite side from the gun. He dragged the gun towards him. I was about twenty yards away from him when the gun went off. He said, 'I am shot, Bob'. He fell immediately. The gun was loaded with shot. The gun now on the table is the same. Stephen Schiskar, deposed: I saw John Meal shoot himself. I am quite certain no person else would have done it. Meal was jumping over a tree. The rest of us were jumping. He went to get on top of the log and he caught hold of the gun; when he caught hold of it it went off. He pulled it towards him. I was about ten yards off, on the opposite side to Sewell. He said, 'Bob, I am shot'. I did not hear him say anything else after that. I saw the gun before it went off. Could not say whether it was cocked or not. He was on top of the log when the gun went off. He run to where the blood is on the ground and then fell. It was after he fell that he spoke. George Meal deposed: John Meal is my brother. I saw him shoot himself, by the gun accidentally going off. He went to jump over the log. He went to catch hold of the gun and the gun went off. The hammer was down on the cap. There were but the three of us present when he shot himself. The father, John Meal, having deposed to the age of the boy being fifteen on the 2nd ultimo, the Jury returned a verdict of 'Accidental Death'.

The remaining four children of John and Elizabeth Meale all married and had children of their own. Their lives will be covered in more detail in later chapters.

John Meale died at Upper Waiwera on 7 January, 1889, from syncope and general debility, after a three week illness. He was buried at Puhoi. On the death registration, his son, Joseph Meale, stated that John was 70 years old, was born in Leeds, had been in New Zealand for 40 years, and was the son of John Meal, a Shoemaker, and his wife, Elizabeth. Research over many years did not find any record of John Meale in the Leeds area, but autosomal DNA evidence suggests that he was born John Fothergill, son of Samuel and Elizabeth Fothergill.

Elizabeth Meale, nee Hemblen, lived on for ten more years, and died at Upper Waiwera on 13 March 1899, from general debility, at the age of 70 years. She too is buried at Puhoi.

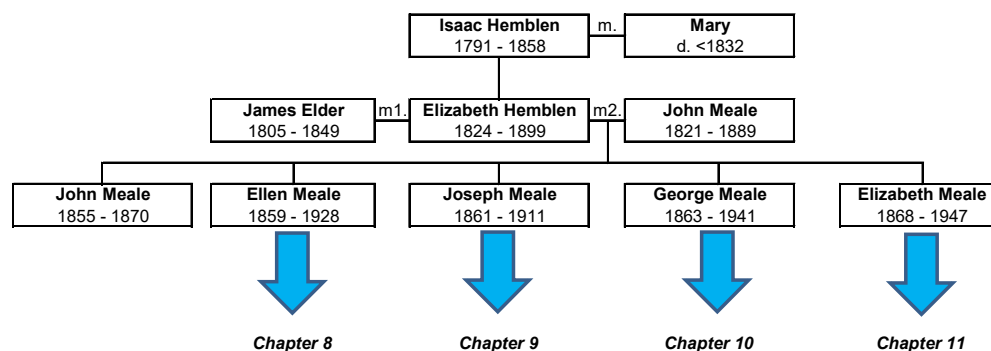

## Chapter 5 – Emma Hemblen (1834 - 1895)

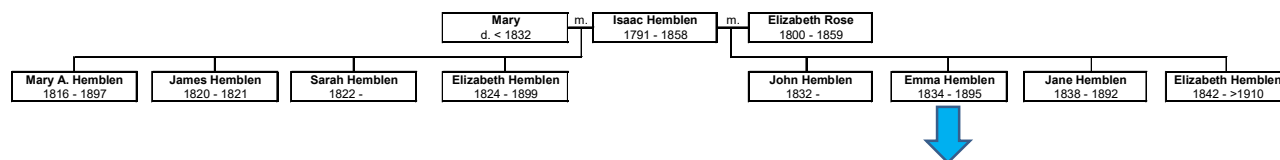

Emma, the eldest daughter of Isaac Hemblen and Elizabeth Rose, was baptized at Bath, Somerset on 9 September 1834.

In the first quarter of 1857, she gave birth to a daughter, whom she named Emma. It is not known who the father was, but it is suspected that it was Patrick Sweeney, as Emma Emblin is found in the 1861 census, living at 22 Milk Street, Bath, with 38 year old Patrick Sweeney, and five year old daughter, Emma Emblin. The young Emma is not found in the 1871 census, so is presumed to have died, or perhaps may have been adopted.

In early 1862, Emma Hemblen gave birth to a son, Alfred Henry Hemblen. Alfred is found in the 1871 census, living with his mother, Emma and boarder, James Howell. It is assumed that Patrick Sweeney was also the father of Alfred, as Emma would have become pregnant around the time of the 1861 census, when she was living with Patrick. No record has been found of Alfred after 1871, so like his sister Emma, is assumed to have died young or been adopted.

On 5 August 1872, Emma Hemblen married James Howell in the Trinity Parish Church in Bath. The witnesses to the marriage were Emma's sister, Jane Stainer and Jane's husband, William C. Stainer. The bride and groom were both living at 12 Avon Street, Bath at the time of their marriage.

A few months after her marriage to James Howell, Emma gave birth to a son, William James Howell, and in early 1876 she gave birth to a second son, John Howell. By the time of John's birth, Emma was a widow, as her husband had died in the July-September quarter of 1875.

Emma and her two sons are found in the 1881 census, living at 87 Avon Street, with Emma listed as a widowed Hawker, and the two boys listed as Scholars.

The Bath Chronicle<sup>xi</sup> of 20 November 1890 details a criminal case against Emma Howell of 65 Avon Street, Bath. The article reports that Rose Amelia Hillier met Emma Howell, coming out of a public house somewhat intoxicated and offered to take her home. Rose then sat with Emma in her home, until Emma heard her son outside, talking to Eliza Stephens, at which time she told her son to come inside as she did not want him "talking to that". When her son came inside, Emma went at him with a knife, but Rose got between them and was stabbed in the hand. The story continued in the same newspaper on 27 November, reporting that Emma was committed for trial at the upcoming Quarter Sessions. The Bath Chronicle of 15 January 1891 reported on page 2 that Emma Howell pleaded guilty to unlawfully and maliciously wounding Rose Amelia Hillier and was sentenced to three months' imprisonment with hard labour.

I have not found a confirmed death record for Emma Howell, nee Hemblen, but she is believed to have died in Bath, Somerset in 1895. The known descendants of Emma and James Howell are as follows - .



1. Emma HEMBLEMEN (c.9 Sep 1834-Bath, Somerset, England; d.1895-Bath, Somerset, England)  
 sp: William James HOWELL (b. Abt 1841-Bath, Somerset, England; m.5 Aug 1872; d. Jul/Sep 1875-Bath, Somerset, England)
  2. William James HOWELL (b. Jul/Sep 1872-Bath, Somerset, England; d.10 Dec 1946-Bath, Somerset, England)
  2. John HOWELL (b.23 Apr 1876-Bath, Somerset, England; d. Oct/Dec 1957-Cardigan, Cardigan, Wales)  
 sp: Margaret EVANS (b. Abt 1868-Llandygydd, Cardigan, Wales; m. Apr/Jun 1895; d.13 Jan 1931-Llandygydd, Cardigan, Wales)
    3. Sarah HOWELL (b. Apr/Jun 1896-Llandygydd, Cardigan, Wales; d. Aft 1900)
    3. James HOWELL (b. Apr/Jun 1899-Llandygydd, Cardigan, Wales; d. Jul/Sep 1963-Carmarthen, Carmarthen, Wales)  
 sp: Mary Adeline FORTY (b.29 Jul 1899; m. Oct/Dec 1919; d.14 Nov 1924)
    4. Islwyn HOWELL (b. Apr/Jun 1920-Newcastle Emlyn, Cardigan, Wales)  
 sp: Amy WELLS (m. Jul/Sep 1942)
      5. David R. HOWELL (b. Jul/Sep 1944-Liverpool, Lancashire, England)
      5. Graham HOWELL (b. Jan/Mar 1946-Liverpool, Lancashire, England)
    4. Alwyne J. HOWELL (b. Jan/Mar 1922-Ledbury, Hereford, England)
    4. Theodosia M. HOWELL (b.20 Feb 1924-Ledbury, Hereford, England; d. Feb 1988-Neath, Wales)  
 sp: James DANCE (b.15 May 1921-Cardiff, Wales; m. Jan/Mar 1946; d.19 Sep 2012-Swansea, Wales)
      5. Julian M. DANCE (b.-Carmarthen, Carmarthen, Wales)  
 sp: Trefor J. PAGE
      5. Barbara A. DANCE (b. -Carmarthen, Carmarthen, Wales)  
 sp: Graham POWELL
      5. Vivian J. DANCE (b.-Carmarthen, Carmarthen, Wales)  
 sp: Meryl R. JONES
      5. Lilian E. DANCE (b.-Carmarthen, Carmarthen, Wales)  
 sp: Vivian CLATWORTHY
3. Margaret HOWELL (b. Jan/Mar 1902-LLandygydd, Cardigan, Wales; d. Aft 1910)
3. Thomas HOWELL (b. Oct/Dec 1906-LLandygydd, Cardigan, Wales; d. Aft 1910)

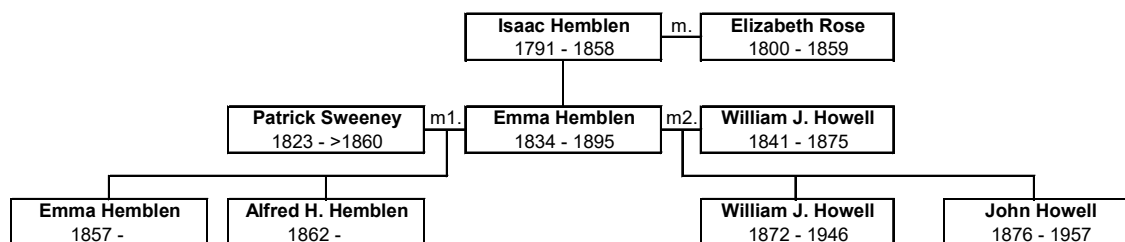

## Chapter 6 - Jane Hemblen and William Stainer Coffin

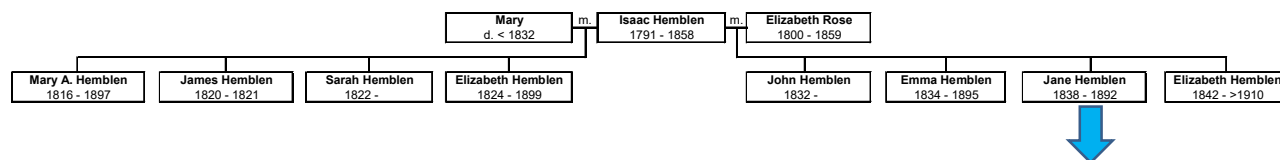

Jane Hemblen was born at Upper Dover Street, Bath on 31 August 1838, the second daughter of Isaac Hemblen and Elizabeth Rose.

At the age of 28 years, Jane married William Stainer Coffin on 7 June 1867 at Trinity Parish, Bath. William was identified on the marriage record as a widower, and a Cutler by trade, son of Thomas Coffin, a Baker.

William Coffin had previously married Christian Nother on 10 August 1845, in the Parish of Wimborne, Dorset. I have found no record of children born to William and Christian Coffin, and no death record for Christian Coffin. I have found records of Christian Coffin appearing before the courts on at least two occasions, but she was found not guilty in both cases.

Jane Hemblen and William Coffin had a total of nine children, with four of those children born before their parents' marriage. The birth registrations are somewhat confusing as two children were registered under the surname Hemblen, four under the surname Coffin and three under the surname Stainer. This surname confusion continued into the next generation, but eventually the Stainer surname was adopted by all male descendants, rather than Coffin, with Coffin sometimes being retained as a second given name.

William Stainer Coffin died in Bath in the first quarter of 1892, and his wife Jane died in the fourth quarter of the same year. Their known descendants are as follows -

1. Jane HEMBLEN (b.31 Aug 1838-Upper Dover St., Bath, Somerset, England; d. Oct/Dec 1892-Bath, Somerset, England)
  - sp: William Stainer COFFIN (b. Abt 1822-Wimborne, Dorset, England; m.7 Jun 1867; d. Jan/Mar 1892- Bath, Somerset, England)
    2. Mary Anne Stainer COFFIN (b. Oct/Dec 1860-Bath, Somerset, England; d. Apr/Jun 1903-Bath, Somerset, England)
      - sp: UNKNOWN
    3. William Charles COFFIN (b. Apr/Jun 1880-Bath, Somerset, England; d. Aft 1890)
      - sp: Louisa HAYWARD (b. Abt 1881-Bath, Somerset, England; m.Oct/Dec 1899; d. Aft 1900)
        4. Alfred POWELL (b. Abt 1900-Bath, Somerset, England; d. Aft 1910)
        4. James POWELL (b. Abt 1900-Bath, Somerset, England; d. Aft 1910)
          - sp: Henry James POWELL (b. Abt 1860-Bath, Somerset, England; m.Jul/Sep 1881; d. Apr/Jun 1918-Bath, Somerset, England)
      - 3. Caroline Joyce POWELL (b. Jan/Mar 1882-Bath, Somerset, England; d.Oct/Dec 1884 -Bath, Somerset, England)
      - 3. William Charles POWELL (b. Apr/Jun 1885-Bath, Somerset, England)
      - 3. Emily POWELL (b. Jan/Mar 1887-Bath, Somerset, England; d. Aft 1890)

- 3. Henry James POWELL (b. Jan/Mar 1889-Bath, Somerset, England; d. Jan/Mar 1890-Bath, Somerset, England)
- 3. Henry James POWELL (b. Jan/Mar 1891-Bath, Somerset, England; d. Apr/Jun 1892-Bath, Somerset, England)
- 2. William Stainer Coffin HEMBLEMEN (b. Oct/Dec 1862-Bath, Somerset, England; d. Aft 1890)  
sp: Florence Emily FLOWER (b. Abt 1863-Sutton Bovry, Wiltshire, England; m. Jul/Sep 1884; d. Aft 1890)
- 2. Thomas Stainer Coffin HEMBLEMEN (b. Abt. Oct 1864; d.21 Jan 1865-Bath, Somerset, England)
- 2. Thomas Coffin STAINER (b. Jan/Mar 1866-Bath, Somerset, England; d. Apr/Jun 1946-Bath, Somerset, England)  
sp: Mary Ann ENEFER (b. Abt 1870-London, England; m. Apr/Jun 1888; d. Abt 1905)
- 3. William Thomas C. STAINER (b. Jul/Sep 1889-Bath, Somerset, England; d. Apr/Jun 1961-Bath, Somerset, England)  
sp: Florence A. ELSBURY (b. Jul/Sep 1888-Bath, Somerset, England; m. Oct/Dec 1921; d. Jan/Mar 1960-Bath, Somerset, England)
- 4. William T. STAINER (b. Jan/Mar 1926-Bath, Somerset, England; d. Jul/Sep 1958-Bath, Somerset, England)
- 4. Edwin J. STAINER (b. Jul/Sep 1929-Bath, Somerset, England)  
sp: Kathleen J.L. HAMLEN (b. Jul/Sep 1930-Bath, Somerset, England; m. Jan/Mar 1952)
- 5. Alan P. STAINER (b. Oct/Dec 1957-Bath, Somerset, England)
- 4. Raymond A. STAINER (b. Apr/Jun 1931-Bath, Somerset, England)  
sp: Gwendoline E. MARSH (m. Apr/Jun 1953)
- 5. Ellen STAINER (b.-Rochford, Essex, England)
- 5. Colin STAINER (b. Jan/Mar 1957-Bath, Somerset, England; d. Jan/Mar 1957-Bath, Somerset, England)
- 5. Christopher J. STAINER (b.-Bath, Somerset, England)
- 3. Florence Coffin STAINER (b. Apr/Jun 1891-Bath, Somerset, England; d. Aft 1910)  
sp: Alfred G. PRICE (m. Jul/Sep 1917)
- 4. Alfred J.G. PRICE (b. Apr/Jun 1918-Hackney, Middlesex, England; d. Jul/Sep 1945-Winchester, Hampshire, England)  
sp: Florence J. GILBY (b. Jan/Mar 1923-Hendon, Middlesex, England; m. Apr/Jun 1941)
- 5. Richard A. PRICE (b. -Hendon, Middlesex, England)
- 3. Mabel Coffin STAINER (b. 30 Jul 1892-Sturminster, Dorset, England; d. 17 Jan 1967-Niagara on the Lake, Ontario, Canada)  
sp: Hunter St. John SOUTHCOTT (b.31 Jul 1890-Isle of Wight, Hampshire, England; m. 5 Mar 1915; d.24 Nov 1980-Niagara on the Lake, Ontario, Canada)
- 4. Aileen SOUTHCOTT (b.7 Feb 1916; d.27 May 2008-Niagara on the Lake, Ontario, Canada)  
sp: Frederick J. WHITTEN (b.2 Jan 1917; d.30 Dec 1980-Niagara on the Lake, Ontario, Canada)
- 3. Lilian STAINER (b. 7 Sep 1895-Bridgewater, Somerset, England; d. 15 May 1977-Peterborough, Ontario, Canada)  
sp: Arthur NORTH (b.1897; m.22 Feb 1922; d.2 Sep 1966-Lindsay, Ontario, Canada)

4. Muriel Lillian NORTH (b.21 Jun 1924-Mariposa, Ontario, Canada; d.31 Jan 2015-Peterborough, Ontario, Canada)  
 sp: Donald Edward TWOHEY (b.1925; d.2020)
3. Thomas Coffin STAINER (b. Jul/Sep 1897-Bath, Somerset, England; d. Aft 1910)
3. Thomas Robert STAINER (b. Jul/Sep 1898-Bath, Somerset, England)
3. Arthur Enefer STAINER (b. 8 Mar 1900-Bath, Somerset, England; d. Oct/Dec 1976-Bath, Somerset, England)  
 sp: Nora ALEXANDER (b.19 Apr 1906-Bath, Somerset, England; m. Apr/Jun 1927; d. 6 Mar 1968)
4. Phyllis Patricia STAINER (b. Jan/Mar 1930-Bath, Somerset, England; d. Apr/Jun 2009-Hampshire, England)  
 sp: Alan R. PETTMAN (b. Jul/Sep 1929-Maidenhead, Berkshire, England; m. Jul/Sep 1949; d.1989)
5. Gloria P. PETTMAN (b. Jan/Mar 1950-Eton, Buckingham, England)  
 sp: James E. EAGLESTONE (b. Oct/Dec 1947-Paddington, London, England; m. Apr/Jun 1968)
5. Christine A. PETTMAN (b. -Eton, Buckingham, England)  
 sp: John A. SMITH
5. Alan D. PETTMAN (b. -Maidenhead, Berkshire, England)  
 sp: Julie P. SPACKMAN (b.-Romsey, Hampshire, England)
5. Jacqueline P. PETTMAN (b. -Eton, Buckingham, England)  
 sp: Allan N. CONNOLLY (b. -Devizes, Wiltshire, England)
5. Carol D. PETTMAN (b. -Eton, Buckingham, England)  
 sp: David M. HAMMILL
5. Wayne Robert PETTMAN (b-Bath, Somerset, England)
4. Nancy Nora MacDonald STAINER (b. Apr/Jun 1934-Clutton, Somerset, England)  
 sp: Philip G. STIEBER (b. Oct/Dec 1926-Reading, Berkshire, England; m. Apr/Jun 1950)  
 sp: Maria Iris WINSLEY (b. Abt 1927; m. Apr/Jun 1969; d. Abt 2008)
4. female STAINER  
 sp: UNKNOWN
5. Diane RIDDLE
3. Alice C. STAINER (b. Apr/Jun 1901-Bath, Somerset, England; d. Aft 1910)
3. Hilda Coffin STAINER (b. Apr/Jun 1902-Bath, Somerset, England; d. Jul/Sep 1902-Bath, Somerset, England)
3. Sidney Charles STAINER (b. Jan/Mar 1904-Bath, Somerset, England)
2. Elizabeth Stainer COFFIN (b. Jan/Mar 1869-Bath, Somerset, England; d. Jan/Mar 1870-Bath, Somerset, England)
2. Elizabeth COFFIN (b. Jan/Mar 1871-Bath, Somerset, England; d. Oct/Dec 1896-Bath, Somerset, England)  
 sp: William Henry DYER (b. Abt 1868-Bath, Somerset, England; m. 14 Jan 1894; d. Oct/Dec 1953-Bath, Somerset, England)
3. male DYER (b. Apr/Jun 1894-Bath, Somerset, England; d. Apr/Jun 1894-Bath, Somerset, England)
3. William Henry DYER (b.26 Mar 1895-Bath, Somerset, England; d.27 Nov 1918-H.M.S. Restless)

- sp: Lily Sarah B. DURBIN (b. Oct/Dec 1898-Bath,Somerset,England; m.Jul/Sep 1918)
2. Emily COFFIN (b. Oct/Dec 1873-Bath, Somerset, England; d. Aft 1880)
2. Samuel Stainer COFFIN (b. Apr/Jun 1875-Bath, Somerset, England; d. Oct/Dec 1947-Bath, Somerset, England)
- sp: Mary Ann HIBBARD (b. Abt 1875-Bath, Somerset, England; m. Jan/Mar 1896; d. Apr/Jun 1946-Bath, Somerset, England)
3. Samuel William STAINER (b. Jul/Sep 1897-Bath, Somerset, England; d. Apr/Jun 1946 -Bath, Somerset, England)
- sp: Louisa Ann PAYTON (b.14 Dec 1896-Bath, Somerset, England; m. Jan/Mar 1922; d. Apr/Jun 1972-Chichester, Sussex, England)
4. Samuel Charles James STAINER (b. 4 Jul 1922-Bath, Somerset, England; d. Oct/Dec 1975-Bristol, Gloucester, England)
- sp: Phyllis J. OWENS (m. Apr/Jun 1944)
4. Reginald Joseph STAINER (b. Jul/Sep 1924-Bath, Somerset, England)
- sp: Patricia J. COX (m. Apr/Jun 1949)
4. Joan Lily STAINER (b. Apr/Jun 1927-Bath, Somerset, England)
- sp: James F. HUMPHRIES (m. Jul/Sep 1947)
4. Phyllis Kathleen STAINER (b. Apr/Jun 1929-Bath, Somerset, England)
- sp: Raymond L. SMITH (m. Oct/Dec 1953)
4. Ronald Alexander STAINER (b. Jan/Mar 1932-Bath, Somerset, England)
- sp: Shirley J. CHARD (m. Jan/Mar 1958)
4. John Herbert STAINER (b. Jul/Sep 1934-Bath, Somerset, England)
4. Maureen Emily STAINER (b. Jul/Sep 1936-Bath, Somerset, England)
- sp: Francis W. HOBBS (m. Oct/Dec 1958)
4. Barbara Margaret Rose STAINER (b. Jul/Sep 1939-Bath, Somerset, England; d. Oct/Dec 1939-Bath, Somerset, England)
3. Mary Louisa STAINER (b. Apr/Jun 1899-Bath, Somerset, England; d. Jan/Mar 1908-Bath, Somerset, England)
3. Elizabeth Kate STAINER (b. Jan/Mar 1901-Bath, Somerset, England; d. Aft 1910)
3. Kate STAINER (b. Apr/Jun 1903-Bath, Somerset, England; d. Aft 1910)
3. Emily STAINER (b. Jul/Sep 1905-Bath, Somerset, England; d. Aft 1910)
3. Annie STAINER (b. Jul/Sep 1907-Bath, Somerset, England; d. Aft 1910)
3. Charles Coffin STAINER (b. Jan/Mar 1910-Bath, Somerset, England; d. Jul/Sep 1928-Bath, Somerset, England)
3. Hilda STAINER (b. Jan/Mar 1912-Bath, Somerset, England)
3. William STAINER (b. 8 Jan 1914-Bath, Somerset, England; d. Aft 1938)
- sp: Rose M. CHAPPELL (b. 29 Jun 1914-Bath, Somerset, England; m. Jul/Sep 1939; d. Aft 1938)
4. Veronica R. STAINER (b. Apr/Jun 1940-Bath, Somerset, England)
- sp: Charles W.H. RUSSELL (m. Jan/Mar 1958)
5. Carolyne RUSSELL (b. -Bath, Somerset, England)
5. Leslie J. RUSSELL (b. -Bath, Somerset, England)
5. Roland RUSSELL (b. -Bath, Somerset, England)
5. Paula RUSSELL (b. -Bath, Somerset, England)
5. Tania RUSSELL (b. -Bath, Somerset, England)
4. Jennifer K. STAINER (b. -Bath, Somerset, England)

sp: Alan R. HEAD

- 5. Julie L. HEAD (b. -Bath, Somerset, England)
- 5. Sharon J. HEAD (b. -Bath, Somerset, England)
- 5. Dawn M. HEAD (b. -Bath, Somerset, England)
- 5. Tina Louise HEAD (b. -Bath, Somerset, England)
- 5. Alan Robert HEAD (b. -Bath, Somerset, England)

2. Charles Stainer COFFIN (b. Jul/Sep 1877-Bath, Somerset, England; d. Jul/Sep 1962-Bath, Somerset, England)

sp: Kate BRITTEN (b. Apr/Jun 1883-Derry Hill, Wiltshire, England; m. Oct/Dec 1903; d. Apr/Jun 1941-Bath, Somerset, England)

3. Chrissy Eva STAINER (b. Oct/Dec 1903-Bath, Somerset, England; d. Aft 1925)

sp: Francis Sidney George TUCKER (b. Apr/Jun 1905-Bath, Somerset, England; m. Jan/Mar 1926)

3. William Alfred STAINER (b. Sep 1904-Bath, Somerset, England; d. Apr/Jun 1973-Bristol, Gloucester, England)

sp: Olive R. MATTHEWS (b. Abt 1912; m. Jul/Sep 1933; d. Apr/Jun 1947-Thornbury, Gloucester, England)

sp: Doreen M. HYETT (b. Apr/Jun 1917-Bristol, Gloucester, England)

3. Kathleen Grace STAINER (b. Jul/Sep 1906-Bath, Somerset, England; d. Aft 1910)

sp: Albert Frederick MEDDICK (b. 6 Jan 1911-Bath, Somerset, England; m. Oct/Dec 1932; d. Jul/Sep 1976-Bath, Somerset, England)

4. Brian A.C. MEDDICK (b. Apr/Jun 1933-Bath, Somerset, England)

sp: Maureen V. FRANKLIN

sp: Stanislaw MACKOWIAK

3. Phyliss Olive STAINER (b. Oct/Dec 1908-Bath, Somerset, England)

sp: Edward F. MILTON (m. Jan/Mar 1936)

3. Jess Constance Coffin STAINER (b. Oct/Dec 1910-Bath, Somerset, England)

sp: William E. HANCOCK (m. Apr/Jun 1937)

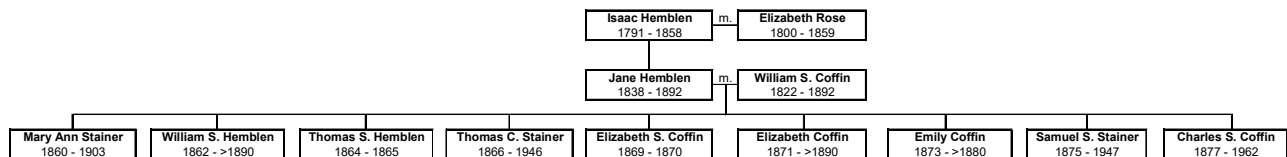

## Chapter 7 – Elizabeth Hemblen and William Thomas

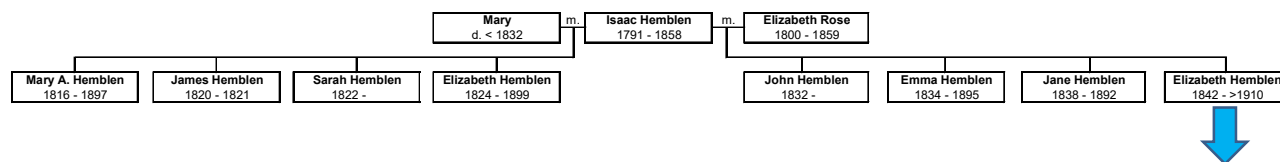

Elizabeth, the youngest child of Isaac Hemblen and Elizabeth Rose was born 9 November 1842 at 1 James Buildings, Bath, Somerset, and she was only 16 years old when her father and mother died in 1858 and 1859 respectively.

Elizabeth Hemblen had a son named John, born circa 1865 (he was six years old in the 1871 census), presumably fathered by William Thomas, who married Elizabeth in the first quarter of 1867 at Bath.

Elizabeth and William Thomas had a total of eleven children between 1865 and 1888, but only four lived into adulthood. The other seven children each died before their sixth birthday.

I have not found definite death records for Elizabeth or William Thomas, but both were still alive at the time of the census in 1911. Their known descendants are as follows -

1. Elizabeth HEMBLEMEN (b. 9 Nov 1842-Bath, Somerset, England; d. Aft 1910)
  - sp: William THOMAS (b. Abt 1833-Bath, Somerset, England; m. Jan/Mar 1867; d. Aft 1910)
  - 2. John THOMAS (b. Abt 1865-Bath, Somerset, England; d. Aft 1910)
    - sp: Ellen DONOVAN (b. Abt 1868-Banstead, Surrey, England; m. Apr/Jun 1888; d. Aft 1910)
    - 3. THOMAS (b. Jul/Sep 1888-Bath, Somerset, England; d. Jul/Sep 1888-Bath, Somerset, England)
    - 3. Annie Elizabeth THOMAS (b. Oct/Dec 1889-Bath, Somerset, England; d. Oct/Dec 1889-Bath, Somerset, England)
    - 3. John THOMAS (b. Jan/Mar 1891-Bath, Somerset, England; d. Jan/Mar 1891-Bath, Somerset, England)
    - 3. Mary Ellen THOMAS (b. Jul/Sep 1892-Bath, Somerset, England; d. Aft 1910)
    - 3. Ada Jane THOMAS (b. Jan/Mar 1894-Bath, Somerset, England; d. Aft 1910)
    - 3. William Joseph THOMAS (b. Apr/Jun 1895-Bath, Somerset, England; d. Aft 1900)
    - 3. George THOMAS (b. Apr/Jun 1898-Bath, Somerset, England; d. Oct/Dec 1898-Bath, Somerset, England)
    - 3. Elizabeth Mary THOMAS (b. Jul/Sep 1899-Bath, Somerset, England; d. Aft 1910)
    - 3. Kathleen Agnes THOMAS (b. Apr/Jun 1904-Bath, Somerset, England; d. Jul/Sep 1904-Bath, Somerset, England)
    - 3. Mary Agnes THOMAS (b. Jan/Mar 1908-Bath, Somerset, England; d. Jan/Mar 1928-Bath, Somerset, England)
  - 2. Ann Elizabeth THOMAS (b. Jan/Mar 1868-Bath, Somerset, England; d. Jan/Mar 1871-Bath, Somerset, England)
  - 2. William THOMAS (b. Jul/Sep 1870-Bath, Somerset, England; d. Jul/Sep 1870-Bath, Somerset, England)

2. Elizabeth THOMAS (b. Oct/Dec 1871-Bath, Somerset, England; d. Oct/Dec 1872-Bath, Somerset, England)
2. Elizabeth THOMAS (b. Oct/Dec 1874-Bath, Somerset, England; d. Aft 1910)  
 sp: Giles EDDY (b. Abt 1864-Bath, Somerset, England; m. 5 Aug 1895; d. Jul/Sep 1909-Bath, Somerset, England)  
 sp: William HOLLOWAY (m. Apr/Jun 1911)
2. William THOMAS (b. Apr/Jun 1877-Bath, Somerset, England; d. Jan/Mar 1881-Bath, Somerset, England)
2. George THOMAS (b. Jan/Mar 1879-Bath, Somerset, England; d. Jul/Sep 1884-Bath, Somerset, England)
2. Ada THOMAS (b. Apr/Jun 1880-Bath, Somerset, England; d. Apr/Jun 1880-Bath, Somerset, England)
2. Ada THOMAS (b. Oct/Dec 1881-Bath, Somerset, England; d. Aft 1910)  
 sp: Albert HILES (b. Abt 1878; m. 13 Feb 1906)  
 3. Arthur HILES (b. Abt 1907-Bath, Somerset, England; d. Aft 1910)  
 3. Ada HILES (b. Abt 1910-Bath, Somerset, England; d. Aft 1910)
2. Henry THOMAS (b. Jul/Sep 1883-Bath, Somerset, England; d. Oct/Dec 1952-Bath, Somerset, England)  
 sp: Florence Lilian NIGHTINGALE (b. Abt 1887-Steeple Ashton, Wiltshire, England; m. Jul/Sep 1905; d. 1911/1928)  
 3. Lilian Doreen THOMAS (b. Jan/Mar 1907-Bath, Somerset, England; d. Apr/Jun 1908-Bath, Somerset, England)  
 3. Henry Charles THOMAS (b. Apr/Jun 1910-Bath, Somerset, England; d. Oct/Dec 1910-Bath, Somerset, England)  
 3. Gertrude Annie THOMAS (b. Jan/Mar 1912-Bath, Somerset, England)  
 sp: Victor R. JONES (m. Oct/Dec 1933)  
 4. Graham V.H. JONES (b. Jul/Sep 1934-Clutton, Somerset, England)  
 sp: Doreen L. BENICE  
 5. Maria A. JONES (b. -Bristol, Gloucester, England)  
 sp: Steven M. REEVES
3. Rosina THOMAS (b. Jul/Sep 1914-Bath, Somerset, England)
3. Lilian Adelaide THOMAS (b. Jul/Sep 1916-Bath, Somerset, England; d. Jan/Mar 1917-Bath, Somerset, England)  
 sp: Florence FORD (m. Jul/Sep 1928)
3. Harry THOMAS
3. William THOMAS (b. Apr/Jun 1922-Bath, Somerset, England)
3. Charles THOMAS (b. Apr/Jun 1923-Bath, Somerset, England)
3. Florence Beatrice THOMAS (b. Jul/Sep 1925-Bath, Somerset, England)
3. John THOMAS (b. Oct/Dec 1927-Bath, Somerset, England)
3. Elizabeth THOMAS (b. Jul/Sep 1930-Bath, Somerset, England)
3. George THOMAS (b. Apr/Jun 1932-Bath, Somerset, England)
3. Albert THOMAS (b. Oct/Dec 1933-Bath, Somerset, England)  
 sp: Mary R. TILEY (b. Oct/Dec 1938-Bath, Somerset, England; m. Jan/Mar 1958)  
 4. Wendy THOMAS (b. -Bath, Somerset, England)  
 sp: Peter A. CALTON (b. -Hemsworth, Yorkshire, England)  
 5. Matthew CALTON (b. -Bath, Somerset, England)



- 3. Walter THOMAS (b. Oct/Dec 1933-Bath, Somerset, England)
- 3. Edward THOMAS (b. Jan/Mar 1936-Bath, Somerset, England)  
sp: Kathe G. ENGELBRECHT (m. Oct/Dec 1955)
  - 4. Frank Edward THOMAS (b. -Bath, Somerset, England)
  - 4. Sandra Maria THOMAS (b. -Bath, Somerset, England)  
sp: Wayne RIDEWOOD (b. -Bath, Somerset, England)
    - 5. Leon Michael Edward RIDEWOOD (b. -Bath, Somerset, England)
    - 5. Shelley Marie RIDEWOOD (b. -Bath, Somerset, England)
  - 4. Colin Dennis THOMAS (b. -Bath, Somerset, England)
  - 4. Teresa Helga THOMAS (b. -Bath, Somerset, England)
- 3. Arthur Henry THOMAS (b. Jul/Sep 1937-Bath, Somerset, England; d. Jul/Sep 1937-Bath, Somerset, England)
- 3. Reginald THOMAS (b. Jul/Sep 1937-Bath, Somerset, England; d. Jul/Sep 1937-Bath, Somerset, England)
- 3. David THOMAS (b. Oct/Dec 1938-Bath, Somerset, England; d. Jan/Mar 1939-Bath, Somerset, England)
- 3. Alan THOMAS (b. Jul/Sep 1940-Bath, Somerset, England)
- 3. Florence THOMAS (b. Oct/Dec 1944-Bath, Somerset, England; d. Oct/Dec 1944-Bath, Somerset, England)
- 2. Emily Elizabeth THOMAS (b. Jul/Sep 1888-Bath, Somerset, England; d. Jan/Mar 1889-Bath, Somerset, England)

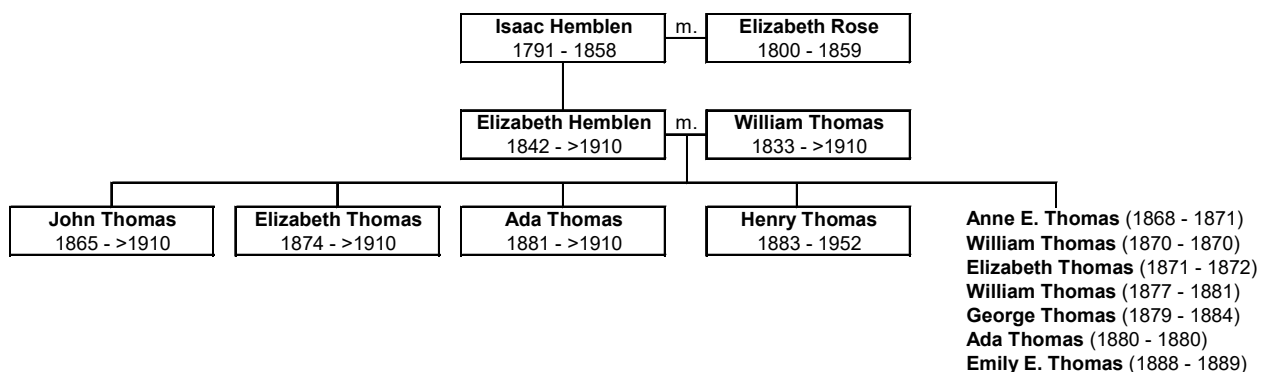

## Chapter 8 – Ellen Meale and James Alexander Cosgrave

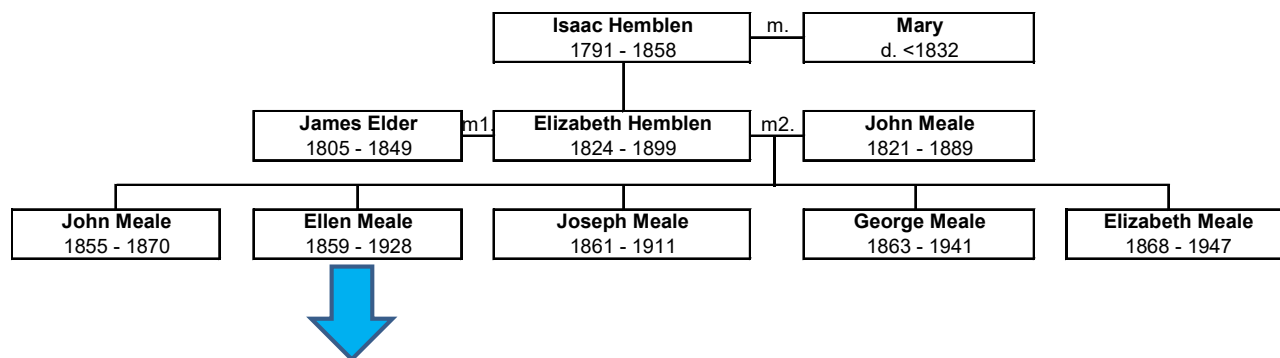

Ellen, the eldest daughter of John Meale and Elizabeth Hemblen, was born at Waiwera, New Zealand on 3 July 1859.

Nineteen year old Ellen Meale married James Alexander Cosgrave, a 25 year old mariner, in the Wade Registry Office on 17 June 1878, and James worked as a bushman before later taking up farming. The marriage produced 8 children, born as follows –

- Sidney James Cosgrave, born 9 February 1879
- Annie Elizabeth Cosgrave, born 23 August 1880
- Ellen Olivia Cosgrave, born 22 June 1882
- Edith Steele Cosgrave, born 14 December 1884
- Vivian John Cosgrave, born 1 May 1887
- George Edward Cosgrave, born 22 August 1889
- Percy Cosgrave, born 17 November 1891
- James Steele Cosgrave, born 16 July 1894

Sidney James Cosgrave married Edith Rosalia Schischka on 21 July 1906 and they had 3 children together, Muriel Joy, Edith Bernice Elizabeth, and Peter George Maurice (Maurice) Cosgrave. This marriage ended in divorce in 1930 and Sidney had three additional children with Una Jessie Leslie – June, Margaret, and John James Steele Cosgrave. Sidney's known descendants are as follows –

1. Sidney James COSGRAVE (b. 9 Feb 1879-Waiwera, New Zealand; d.23 Mar 1963-Epsom, Auckland, New Zealand)  
sp: Edith Rosalia SCHISCHKA (b.23 Oct 1881-Auckland, New Zealand; m.21 Jul 1906 (Div); d. 9 Jan 1968 - Remuera, New Zealand)
2. Muriel Joy COSGRAVE (b.22 Aug 1907-Auckland, New Zealand; d.2 Sep 1989-Auckland, New Zealand)
2. Edith Bernice Elizabeth COSGRAVE (b.4 Nov 1908-Auckland, New Zealand; d.1 Apr 1985-Whangarei, New Zealand)  
sp: Peregrine Theodore Harry LEDIARD (b.14 Dec 1907-Wandsworth, London, England; m. 23 Aug 1930; d.18 Dec 1983-New Zealand)
3. Mary Elizabeth Dawn LEDIARD (b.5 Mar 1931-Auckland, New Zealand; d. 5 Nov 1984-New Zealand)

- sp: William BRADSTREET (b.30 Nov 1926; m.1950; d.11 Dec 1991-New Zealand)
- 3. Peregrine David Walter LEDIARD (b. 15 Jan 1941-Auckland, New Zealand)
- sp: Christine
- 3. Linda Anne LEDIARD (b. 1948-Auckland, New Zealand)
- 2. Peter George Maurice COSGRAVE (b.14 Jun 1917-Auckland, New Zealand; d.6 Nov 2001-Auckland, New Zealand)
- sp: Reama DAWAI (d. 25 Feb 1975-Fiji)
- 3. Lorima Davu COSGRAVE (b. Nadi, Fiji)
- sp: Rebecca Margaret PAERAU (b. Te Kauwhata, New Zealand;)
- 4. David Laurie COSGRAVE (b. Auckland, New Zealand)
- 4. Sandra Anamere COSGRAVE (b. Auckland, New Zealand)
- 4. Maurice COSGRAVE (b. Auckland, New Zealand)
- 4. Phillip Davu COSGRAVE (b. Auckland, New Zealand)
- 4. Billy COSGRAVE
- sp: Una Jessie LESLIE (b.11 Jan 1910-New Zealand; d.1 Apr 2002-New Zealand)
- 2. June COSGRAVE
- 2. Margaret COSGRAVE
- 2. John James Steele COSGRAVE (b.30 Apr 1940-Auckland, New Zealand; d.12 Oct 2011-New Zealand)
- sp: Marion Janice HINTON
- 3. Carol Ann COSGRAVE
- 3. Paul John COSGRAVE (b. Howick, Auckland, New Zealand)
- sp: Jennine MCDONALD

Annie Elizabeth Cosgrave married Alexander James Jamieson in Waiwera on 27 December 1904, and the marriage produced 5 children. Annie died in Auckland on 20 February 1942, and Alexander died seven years later, on 30 June 1949, also in Auckland. Their known descendants are as follows –

- 1. Annie Elizabeth COSGRAVE (b.23 Aug 1880-Waiwera, New Zealand; d.20 Feb 1942-Auckland, New Zealand)
- sp: Alexander James JAMIESON (b.13 Apr 1881-Mahurangi, New Zealand; m.27 Dec 1904; d.30 Jun 1949-Auckland, New Zealand)
- 2. Mona Pearle JAMIESON (b.13 Apr 1904-Mahurangi, New Zealand; d.27 Jun 1977-New Zealand)
- 2. Edith Helen JAMIESON (b.16 Nov 1906-Mahurangi, New Zealand; d.17 May 1987-Auckland, Auckland, New Zealand)
- sp: Owen Curran BURNS (b.29 Aug 1898-New Zealand; m.4 Apr 1928; d.6 Mar 1986-New Zealand)
- 2. Percy Alexander JAMIESON (b.8 Sep 1908-Mahurangi, New Zealand; d.20 Jul 1962-Invercargill, Southland, New Zealand)
- sp: Eunice Rose AFFLECK (b.13 Nov 1913-New Zealand; m.8 Sep 1937; d.21 Jul 2000-New Zealand)
- 3. Yvonne JAMIESON
- 3. Beverley JAMIESON
- 2. Charles Govan JAMIESON (b.15 Jul 1910-Mahurangi, New Zealand; d.1970-New Zealand)

sp: Elsie May MCLENNAN (b.13 Jan 1911-New Zealand; m.9 Feb 1935; d.1999-New Zealand)

3. Jocelyn Merle JAMIESON (b. Abt 1936)

sp: Don BRIDGE

4. Craig Donald BRIDGE

3. Donald Robin JAMIESON (b. Abt 1939; d.13 Feb 1944-New Zealand)

3. Glenys Carol JAMIESON

sp: Robert G. WALTERS

4. Janine WALTERS

2. James Edmund George JAMIESON (b.3 Jul 1915-Mahurangi, New Zealand; d.16 Apr 1992-New Zealand)

sp: Florence Waikato COLLARD (b.10 Apr 1916-New Zealand; m.21 Feb 1934 (Div); d.18 Oct 2009-New Zealand)

3. Anne JAMIESON

3. Patricia JAMIESON

sp: Irene Liliias MEHARRY (b.5 May 1908-New Zealand; m.1943; d.30 Jan 2006-N.Z.)

3. Roderick JAMIESON

3. Valerie JAMIESON

Ellen Olivia Cosgrave married Angus Joseph Jamieson, brother of her brother in law, Alexander James Jamieson, in Mahurangi in 1910. Ellen and Angus had two children together. Angus Jamieson died in Auckland on 17 October 1926. In 1941 Ellen married Elijah Parker, and she died in 1964. Elijah died the following year. Ellen Olivia Cosgrave's known descendants are as follows –

1. Ellen Olivia COSGRAVE (b.22 Jun 1882-Waiwera, New Zealand; d.18 Dec 1964-New Zealand)

sp: Angus Joseph JAMIESON (b.15 Jul 1877-Mahurangi, New Zealand; m.29 Jun 1910; d.17 Oct 1926- Auckland, New Zealand)

2. Harold Joseph JAMIESON (b.4 Apr 1911-New Zealand; d.9 May 1986-New Zealand)

sp: Margaret Theresa HANNON (b.7 Dec 1912; m.8 May 1935; d.9 Jun 2007-N.Z.)

3. Dawn Margaret JAMIESON (b.9 Oct 1936; d.6 Sep 2016-New Zealand)

sp: RICHARDSON

4. Terry RICHARDSON

4. Tracy RICHARDSON

4. Julie RICHARDSON

3. Marlene R. JAMIESON

sp: Gary L. ROSE

3. Lorraine JAMIESON

sp: KERR

2. Sidney George JAMIESON (b.6 Oct 1913-New Zealand; d.17 Jun 1992-Wellington, Wellington, New Zealand)

sp: Leonie Edna WADSWORTH (b.27 Jul 1920-New Zealand; m.1944; d.15 Feb 1976-Wellington, Wellington, New Zealand)

sp: Elijah PARKER (b. Abt 1883; m.1941; d.9 Nov 1965-New Zealand)

Edith Steele Cosgrave married Lewis Brunton in the Presbyterian Church at Wade on 13 January 1904, and they had six children. Lewis died 3 March 1947 in Hamilton, and Edith died 23 January 1984 in Tauranga. Their known descendants are as follows –

1. Edith Steele COSGRAVE (b.14 Dec 1884-Upper Waiwera, New Zealand; d.23 Jan 1984-Tauranga, New Zealand)  
sp: Lewis BRUNTON (b.24 Nov 1881-Orewa Falls, Wade, New Zealand; m.13 Jan 1904; d.3 Mar 1947- Hamilton, Waikato, New Zealand)
2. Lewis Vivian Robert BRUNTON (b.30 Oct 1906-Hamilton, Waikato, New Zealand; d.15 Apr 1984-Tauranga, Bay Of Plenty, New Zealand)  
sp: Beatrice May WILD (b.20 Feb 1912; m.19 Dec 1936; d.20 Nov 1993-New Zealand)
3. Malcolm BRUNTON  
sp: Eyvonne
3. Merrilyn Gail BRUNTON  
sp: Lynden David ADAM
2. Eva Florence BRUNTON (b.1908-Waiwera, New Zealand; d.13 Apr 1969-Gisborne, New Zealand)  
sp: Thomas Henry LYNES (b.13 Nov 1899-Shutford, Oxford, England; m.23 May 1928; d.12 Nov 1981-New Zealand)
3. Colleen Ralda LYNES (b.1929; d.1998-Florida,United States of America)  
...sp: James RENNIE (m.1948 (Div))
3. Dennis George LYNES (b.13 Sep 1933; d.16 Jul 1985-Queenstown, Otago, New Zealand)  
...sp: Shirley VALLANCE (b.31 May 1933; m.1954 (Div); d.31 Mar 2011-New Zealand)
4. Robin Larry LYNES
4. Cheryl Jane LYNES  
...sp: ROBINSON
4. Andrea Karen LYNES (b.1960; d.31 Jan 2019-Queenstown, Otago, New Zealand)  
...sp: Steven Frederick NICOLLE  
...sp: Beau RAPLEY
4. Victoria LYNES
4. Katrina LYNES
4. Jodi LYNES  
...sp: Priscilla Jane (m.1968/1975(Div))  
...sp: Elaine Mary JACKSON (b.26 Apr 1940; m.1975/1985; d.20 Apr 2011-New Zealand)
3. Larry Michael LYNES
2. Cecil Edgar BRUNTON (b.13 May 1908-Waiwera, New Zealand; d.13 May 1988)  
sp: Melba BRADLEY (b.21 Apr 1917; m.1942; d.1989-New Zealand)
3. female BRUNTON  
sp. Francis JACOBSON
4. Cheryl JIMENEZ
2. Alan George BRUNTON (b.30 Aug 1910-Waiwera, New Zealand; d.5 Dec 1941-Egypt)
2. Kenneth Leslie BRUNTON (b.19 Dec 1911-Mahurangi, New Zealand; d.21 Feb 1984-Orewa, N.Z.)  
sp: Marjorie Rosina Marion SUBRITZKY (b. Abt 1910; m.21 Oct 1932 (Div); d.16 Jun 1968-New Zealand)
3. Loyce Ruth Steele BRUNTON (b.9 Aug 1934; d.25 Apr 1998-New Zealand)

sp: Peter David MAJOR

4. Shane

4. Paul

4. Dean

4. Simone

3. Gayle BRUNTON

3. Carl BRUNTON

3. Anne BRUNTON

sp: Cynthia Mae MORRISON (m.1949(Div))

2. George Mervyn BRUNTON (b. 16 May 1916-Hamilton, New Zealand; d.14 Dec 1996-New Zealand)

sp: Maisie Priscilla EVANS (b.7 Aug 1922; m.1948 (Div); d.2002-New Zealand)

sp: Dawn Eleanor

Vivian John Cosgrave married Justine Ursula Brady and their family will be covered in more detail in chapter 11.

George Edward Cosgrave and James Steele Cosgrave (jnr.) both served in World War I and made the ultimate sacrifice. Their short lives will be covered in chapters 13 and 14 respectively.

Percy Cosgrave joined the New Zealand Police on 27 March, 1914, and was stationed at Wellington's Mount Cook Police Station. He married a widow named Imelda Coogan (nee Mooney) in the Wellington Registrar's office on 17 October, 1918. Imelda's first husband, James Hobson Coogan, had died in 1915, and they had a daughter, Mary Ellen Gertrude Coogan, who was born 24 October 1904. Percy and Imelda did not have any children together.

The Evening Post newspaper of 4 April 1921<sup>xii</sup>, identifies that "Constable P. Cosgrave, who has been stationed at Mount Cook (Wellington) Police Station for the past seven years, has resigned, in order to take over the Pier Hotel, Kaikoura".

The hotel business did not go well for Percy, and on the 9th of April, 1923 he filed for bankruptcy. Percy stated that he had had bad luck with the hotels that he had gone into, and came away with nothing. His creditors received 2 shillings and 6 pence per pound owed (12.5%).

Percy took on the family farm at Upper Waiwera, but after the death of his mother, the farm was sold and Percy worked for Auckland brewers *Hancocks*, employed as a relieving manager at several hotels, notably the Astor in Auckland, the Northern Wairoa in Dargaville, and the Palace in Rotorua.

He died in Auckland on 25 September 1964, and is buried in Auckland's Waikumete cemetery. Imelda died in Wellington on 25 July 1966.

James Alexander Cosgrave and Ellen Meale farmed at Upper Waiwera, where they raised their 8 children. In April 1921, their son Percy had purchased the Pier Hotel in Kaikoura, and James Alexander Cosgrave visited Percy later that year. James Alexander Cosgrave's death certificate identifies that he died of a cerebral hemorrhage at the Pier Hotel on 6 December 1921, and he is buried in the Kaikoura cemetery. A story passed down in the family is that James was playing with a group of children in the hotel, and fell down the stairs, landing on his head. After the death of her husband, Ellen Cosgrave (nee Meale) continued farming at Upper Waiwera, with assistance from her son Percy. Ellen died of acute bronchitis on 13 July 1928, at the home of her sister in Cambridge. She is buried in the Cambridge cemetery.



(l-r) James, Margaret & Patricia Cosgrave at the grave of James Alexander Cosgrave.

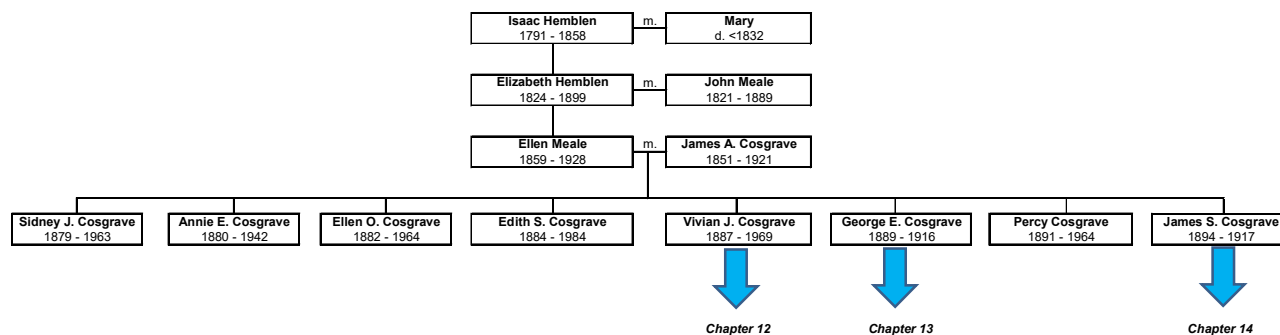

## Chapter 9 – Joseph Meale and Catherine Margaret Logue

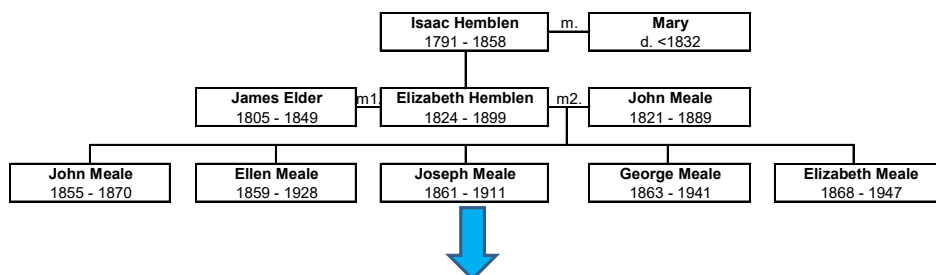

Joseph Meale was born in May 1861 at Waiwera, the second son of Elizabeth Hemblen and John Meale.

On 30 December 1896, at the age of 35 years, Joseph Meale married 27 year old Catherine Logue, who was born in nearby Mangawhai. This marriage produced six children. The second child, Joseph Sweeney Meale served in the Otago Regiment of the New Zealand Expeditionary Force in World War One, and died of disease in France on 18 October 1918 at 20 years of age. He is buried in the Etaples Military Cemetery.

Joseph Meale crushed his foot in May 1896 which necessitated him spending 11 days in Auckland Hospital.

He died on 8 February 1911, at Upper Waiwera, and is buried in Puhoi Cemetery. His wife Catherine lived for 33 years after Joseph's death, and passed away in Auckland on 11 February 1944 at the age of 75 years.

The known descendants of Joseph and Catherine Meale are as follows –

1. Joseph MEALE (b. May 1861-Waiwera, New Zealand; d. 8 Feb 1911-Upper Waiwera, New Zealand)

sp: Catherine Margaret LOGUE (b. Abt 1869-Mangawhai, New Zealand; m. 30 Dec 1896; d. 11 Feb 1944-Mt. Albert, Auckland, New Zealand)

2. Annie Emily MEALE (d. Bef 1944)

2. Joseph Sweeney MEALE (b. 30 Dec 1897-Waiwera, New Zealand; d.18 Oct 1918-France)

2. John Loughlin MEALE (b.10 Nov 1899-Puhoi, New Zealand; d.22 Jul 1950-Whangaroa, New Zealand)

sp: Edith Brenda SHEPHERD (b. 26 Jan 1908-New Zealand; m. 6 Oct 1928; d. 22 May 1984-New Zealand)

2. James Hugh MEALE (b.1900-Puhoi, New Zealand; d. Bef 1944)

2. Cecilia Mary MEALE (b.7 Dec 1903-Upper Waiwera, New Zealand; d.10 Dec 1978-Auckland, New Zealand)

sp: Alexander William JARRATT (b. Abt 1894; m.10 Jan 1926; d. Bef 1979)

3. Desmond Joseph JARRATT (b.18 Jan 1927; d. 21 May1992-New Zealand)

sp: Olga

4. Suzanne JARRATT

4. Toni JARRATT



- 3. Grahame Locklin JARRATT (b.10 Jan 1929; d.5 Oct 2011-New Zealand)  
 sp: Eunice Winifred WRIGHT (b.7 Mar 1928; m.1953; d.4 Jul 2013-New Zealand)
  - 4. Gregory Laughlin JARRATT (b. 1954; d. 2010)
  - 4. Robyn C JARRATT
  - 4. Linda C JARRATT
- 2. Doris Catherine MEALE (b.4 Feb 1908-New Zealand; d.1 May 2002-New Haven, Connecticut, USA)  
 sp: Larry SLOANE

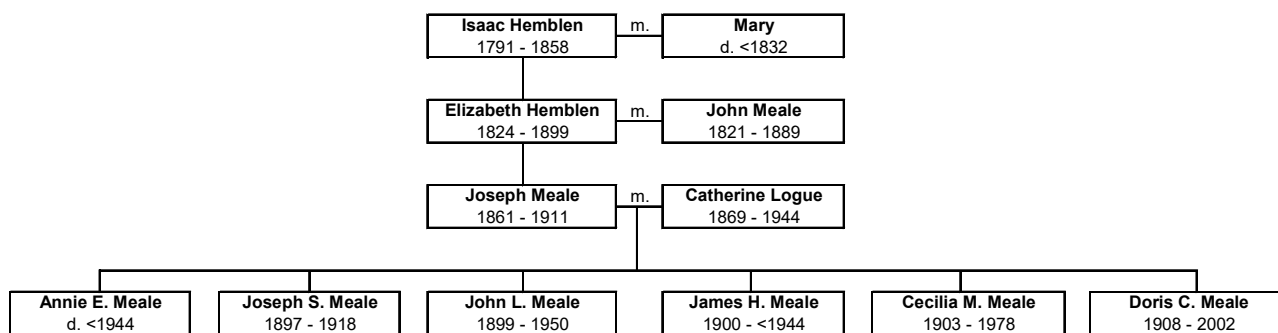

## Chapter 10 – George Meale and Edith Mary Faithfull

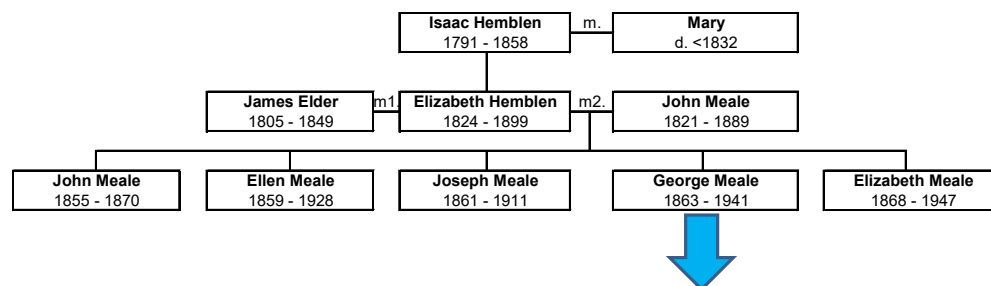

George, the fourth child of Elizabeth Hemblen and John Meale, was born 7 May 1863 at Mahurangi.

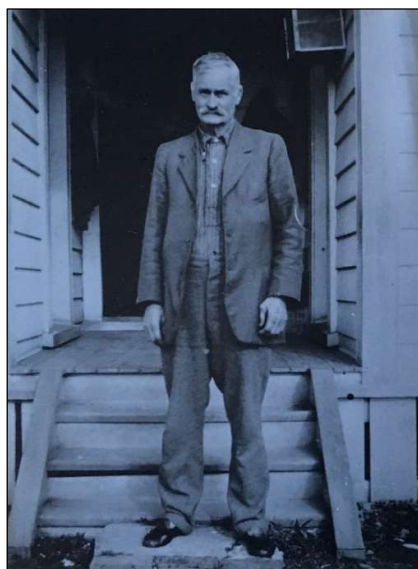

**George Meale.**



**Edith Mary Faithfull.**

On 26 June 1884, George Meale, a 21 year old Farmer married 17 year old Edith Mary Faithfull, at the Wade Registry Office.

Edith was born at Redhill, Surrey, England, and had come to New Zealand as a child, with her parents, Henry Faithfull and Emily Mary Cotterill.

George and Edith Meale's marriage produced seven children, and all but one reached adulthood, married and had children of their own.

George Meale died 26 February 1941 at the age of 77 years, and is buried at Kaihu.

His wife, Edith Meale, nee Faithfull, died at Hastings, Hawkes Bay on 1 September 1954 aged 86 years.

The known descendants of George and Edith Meale are as follows –

1. George MEALE (b.7 May 1863-Mahurangi, New Zealand; d.26 Feb 1941-Te Kopuru, New Zealand)

sp: Edith Mary FAITHFULL (b.21 Oct 1867-Redhill, Surrey, England; m.26 Jun 1884; d.1 Sep 1954-Hastings, New Zealand)

2. Edith Emily MEALE (b.7 Jan 1885-New Zealand; d.3 Jul 1951-New Zealand)

sp: Arthur John Edward SCHISCHKA (b. 17 Dec 1880-New Zealand; m.3 Feb 1904; d. 30 Nov 1960-New Zealand)

3. Kathleen Irene SCHISCHKA (b.5 Nov 1904-Glorit, North Auckland, New Zealand; d.28 Sep 1986-Te Awamutu, New Zealand)

sp: Harold Albert BELCHAMBER (b.2 Jun 1898-Auckland, New Zealand; m.31 Mar 1926; d. 31 Aug 1969-New Zealand)

4. Joan Irene BELCHAMBER (b.22 Nov 1926-Auckland, New Zealand; d.13 Mar 2019-New Zealand)
  - sp: Frederick Edward James BURNELL (b.14 Jan 1928; m.5 Nov 1949; d.15 Oct 1990-New Zealand)
4. Arthur John BELCHAMBER (b.23 Mar 1928-Auckland, New Zealand; d.24 Jun 2008-Dunedin, New Zealand)
  - sp: Betty Olive TREMAIN (m.29 Jan 1952; d.7 Nov 2006)
4. Jessie Edith BELCHAMBER (b.28 Aug 1930-Auckland, New Zealand; d. 28 Feb 2020-Auckland, New Zealand)
  - sp: Gordon Ernest MORROW (b.4 May 1925; m.15 Dec 1951; d.3 Mar 1998-N.Z.)
4. Peter Ernest BELCHAMBER (b.6 Apr 1935-Auckland, New Zealand; d.21 Jun 2020-Hamilton, Waikato, New Zealand)
  - sp: Marlene STREIBEL
4. Neilane Rosemary BELCHAMBER (b.-Hamilton, New Zealand)
4. Philip Gordon Frederick BELCHAMBER (b.-Hamilton, New Zealand)
3. Vera Edith SCHISCHKA (b.23 Jun 1906-Glorit; d. 14 Jan 1985-New Zealand)
  - sp: William Edward SALLEN (b. 1 Jul 1908-New Zealand; m.19 Jan 1939; d. 9 Jun 1967-New Zealand)
    4. Vera SALLEN (b. 2 Jan 1941-New Zealand; d.6 Jan 1941-Takapuna, New Zealand)
    4. Graham Edward SALLEN (b. 26 Sep 1942-Auckland, New Zealand; d. 31 Aug 2020-Auckland, New Zealand)
    4. Murray Philip SALLEN
3. Stephen George SCHISCHKA (b.14 Jan 1909-Glorit, North Auckland, New Zealand; d.12 Aug 1993-Hobsonville, Auckland, New Zealand)
  - sp: Florence Egmont Vera MILLEN (b.16 Jan 1912-Auckland, New Zealand; m. Jul 1938; d. 18 Feb 1984-New Zealand)
    4. Terence Stephen SCHISCHKA
      - sp: Effie May SUNDERLAND
    4. Colleen Margaret SCHISCHKA (b.14 Nov 1941; d. 27 Mar 2018-Te Aroha, Waikato, New Zealand)
      - sp: Colin Charles Henry WELLER (b.1 Feb 1940-Auckland, New Zealand; m.24 Oct 1959; d.14 Oct 1989-Auckland, New Zealand)
    4. Edward Logan SCHISCHKA
      - sp: Patricia HARRISON
    4. Owen Percy SCHISCHKA
      - sp: Lynette BISMAR
    4. James Kennett SCHISCHKA
    4. Carol Elizabeth SCHISCHKA
    4. Jeanette Vera SCHISCHKA
3. Kenneth Arthur SCHISCHKA (b.11 Jun 1912-Glorit, New Zealand; d.16 Oct 1994-Kaeo, New Zealand)
  - sp: Asta Gertrude SMITH (b. 7 Nov 1913-New Zealand; m. 5 Jan 1935 (Div); 14 Nov 1969-Auckland, New Zealand)
    4. Kenneth Leslie SCHISCHKA (b. 20 Apr 1938; d. 3 Sep 2021-New Zealand)
      - sp: Janet Eileen

- sp: Gabriella Eva HILL (b.13 Jul 1913-New Zealand; m. 20 Aug 1941; d. 24 Jul 1984-New Zealand)
4. Carol Ellen SCHISCHKA  
 sp: Bevin Stuart SWITZER (b.29 Jun 1933; m. 1956; d. 15 Sep 1976-New Zealand)
3. Isobelle Faithfull SCHISCHKA (b.24 Feb 1917-Kumeu, North Auckland, New Zealand; d. 4 Nov 2004-New Zealand)
- ...sp: John William Henry Crosby (m. 5 Jan 1937 (Div))  
 sp: Thomas D'Arcy HUGHES (b.10 May 1916; m.16 Feb 1966; d.2 Jun 1990-N.Z.)
4. Jennifer Anne HUGHES (b.-Auckland, New Zealand)
2. John Henry MEALE (b. 27 Sep 1886-Waiwera, New Zealand; d.4 Jan 1960-Aranga, New Zealand)
- sp: Mary Gertrude Geraldine NELSON (b.20 Oct 1892-Auckland, New Zealand; m.28 May 1913; d.18 Nov 1976-Whangarei, Northland, New Zealand)
3. George Martin Raymond MEALE (b.16 Oct 1913-Auckland, New Zealand; d.28 May 1990-New Plymouth, New Zealand)
- pt: Ivy Ethel MORFETT (b.3 Oct 1913-New Zealand; d. 27 Jan 1995-New Zealand)
4. Rex MORFETT (b.-New Zealand)
- sp: Evelyn Florence PATON (b.5 Jul 1908; m.1934 (Div); d.23 Sep 1984-N.Z.)
4. Shirley Lois MEALE (b.1 Apr 1936)  
 sp: John MILLER
4. Allan John MEALE (b.2 Sep 1940-New Plymouth, Taranaki, New Zealand; d.22 Dec 2001-Surrey, British Columbia, Canada)  
 sp: Delores FITZMAURICE (b. 28 Dec 1946-Vancouver, British Columbia, Canada; d.20 Aug 2001-Surrey, British Columbia, Canada)
5. Laura Ann MEALE  
 5. John Raymond MEALE
- sp: Patricia Eleanor POWELL (b.17 Nov 1927; m. Aft 1955; d.5 May 1990-New Plymouth, New Zealand)
4. Raewyn MEALE  
 4. Pamela MEALE
3. John Aubrey MEALE (b.25 May 1915-Dargaville, New Zealand; d. 24 Sep 1993-N.Z.)  
 sp: Lilian Evelyn SHERMAN (b.20 Oct 1919-New Zealand; m.6 Nov 1937; d.14 Sep 1940-Wairoa, New Zealand)
4. Merle Lorraine MEALE (b. Apr 1938; d.24 Jun 1938-Auckland, New Zealand)
- sp: Joan Lillian SMITH (b.31 Dec 1926; m.1946; d.27 Dec 2014-Auckland, N.Z.)
4. Dianne Rosina Joan MEALE  
 sp: Frederick Eric G. KIRMAN
4. Dawn Joyce MEALE  
 sp: PRICE
4. Lorraine MEALE  
 sp: Stephen Alexander STRACHAN
3. Allen Verdun MEALE (b.17 Aug 1916-Dargaville, New Zealand; d.7 Feb 1989-Ruawai, New Zealand)
- sp: Veronica May HACKETT (b. Abt 1918; m.1956; d.10 Aug 1965-New Zealand)
4. Geraldine MEALE

- 4. Helen MEALE
- 3. Colin Norman Joseph MEALE (b.8 Feb 1924; d.9 Apr 2014-Whangarei, N.Z.)
  - sp: Vera Avis WILLIAMS (b.16 Jan 1927; m.1945 (Div); d.2 Jul 1994-Whangarei, N.Z.)
  - sp: Margaret Jean Lillian PAGE (b.30 Sep 1926; m.1952; d.25 Dec 1990-Ruakaka, New Zealand)
    - 4. Kenneth William MEALE (b. Abt 1953; d. 11 Aug 2003-New Zealand)
    - 4. Sharron Anne MEALE
      - sp: Kevin Kaye WHITEHEAD
  - 3. Kenneth Theodore MEALE (b.26 Dec 1931-New Zealand; d.6 Jul 1948-Auckland, New Zealand)
- 2. George Frederick MEALE (b.27 Nov 1888-Pukekararu, New Zealand; d.17 Apr 1959-Howick, Auckland, New Zealand)
  - sp: Elizabeth Sarah THOMPSON (b. Abt 1891-Thames, New Zealand; m.24 Dec 1913; d.21 Aug 1975-Howick, New Zealand)
    - 3. Gwendoline Margaret MEALE (b.1914-Dargaville, New Zealand; d.15 May 1937-Auckland, New Zealand)
    - 3. Valmar Frederick Henry MEALE (b.9 Feb 1916-Dargaville, New Zealand; d.18 Nov 2005-New Zealand)
      - sp: Kathleen Margaret Bridget SINGER (b.25 Aug 1920-New Zealand; m.1943; d.2 Oct 1985-Auckland, New Zealand)
        - 4. Donald Frederick MEALE
          - sp: Colleen
        - 4. Judith Gwendoline MEALE
          - sp: Craig BARRON
      - 3. Cecil George MEALE (b. Abt 1925-New Zealand; d.17 Jul 1952-New Zealand)
  - 2. Ellen MEALE (b. 27 Dec 1890-Waiwera, New Zealand; d.27 Dec 1890-New Zealand)
  - 2. Norman Stanley MEALE (b.13 Mar 1892-Waiwera, New Zealand; d.8 Apr 1980-Te Aroha, Waikato, New Zealand)
    - sp: Dalice Margaret BRADY (b.1 May 1901-New Zealand; m. 12 Apr 1922 (Div); d.27 Jun 1986-Dargaville, Northland, New Zealand)
    - sp: Phoebe HILTON (b. Abt 1910; m.6 Jun 1933; d.31 May 1968-Waihou, Waikato, New Zealand)
      - 3. Robert MEALE (b.9 Mar 1934; d.15 May 2017-Warkworth, Northland, New Zealand)
        - sp: Shirley Ann BRUCE (b. 12 Apr 1940-New Zealand; d. 12 May 2024-New Zealand)
          - 4. Steven Hilton MEALE
          - 4. Andrew Braden MEALE
      - 3. Miriam Joan MEALE (b.22 Mar 1936; d. 17 Oct 2007-New Zealand)
        - sp: Norman William STEWART (b. Abt 1925; m. 1956; d. 29 Jun 2020-New Zealand)
      - 3. Stuart James MEALE
        - sp: Sue PAULSEN
      - 3. Allison Clare MEALE
        - sp: Arnold MALCOLM
  - 2. Margaret Ivy MEALE (b.11 Jul 1897-New Zealand; d.12 Oct 1981-Auckland, Auckland, New Zealand)
    - sp: Albert Tom WALKER (b. 11 Apr 1885-New Zealand; m.10 Jan 1917; d. 15 Apr 1958-Howick, Auckland, New Zealand)

3. Valerie Dawn WALKER (b.20 Aug 1925-Hastings, New Zealand; d.23 Nov 1994-Kaitaia, New Zealand)  
 sp: Clarence William STEVENS (b.16 Feb 1920-New Zealand; m.18 Aug 1948; d.9 Sep 1980- New Zealand)
4. Christopher Robin STEVENS (b.-Taupo, New Zealand)  
 sp: Aldyth RODES
4. Jaqualine Ann STEVENS (b. -Taupo, New Zealand)  
 sp: Selwyn Charles NORTON (b.-Auckland, New Zealand)
4. Peggy Marie STEVENS (b. -Taupo, New Zealand)  
 sp: Graeme CASSIDY (b. -Christchurch, New Zealand)  
 sp: Maurice George POWER (b.2 Sep 1916-Auckland, New Zealand; m.26 May 1963; d.7 Jul 1999-New Zealand)
2. Kenneth Arthur MEALE (b.29 Jun 1899-New Zealand; d.1 Feb 1982-Auckland, New Zealand)  
 sp: Jessie Ann LOCK (b.1 May 1904-N.Z.; m. 23 Aug 1923; d.23 Sep 1979-Auckland, New Zealand)
3. Betty MEALE (b.7 Mar 1924-New Zealand; d.4 Oct 1998-Queensland Australia)  
 sp: Dennis Geoffrey ANNEAR (b.1922-New Zealand; m.1946; d.20 Jul 2002-Hope Island, Queensland, Australia)
4. Judy ANNEAR
4. male ANNEAR (d.2015-Cambodia)
3. Trevor MEALE (b.11 Nov 1928; d. 21 May 2010-New Zealand)  
 sp: Beryl TAYLOR
3. Brian MEALE  
 sp: Jean

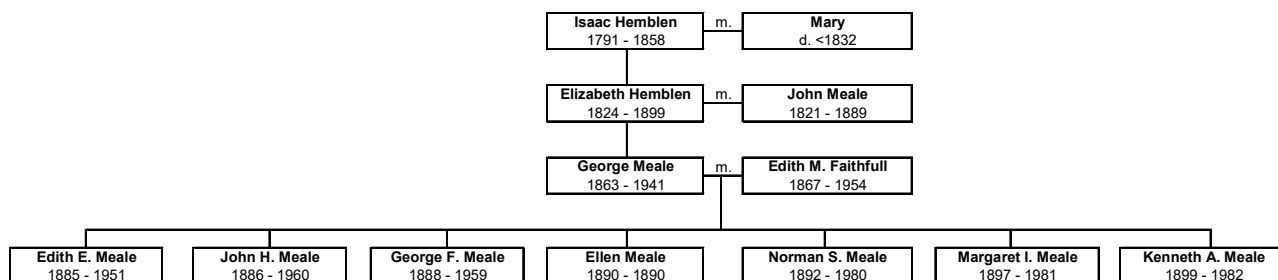

## Chapter 11 – Elizabeth Meale and Thomas Kelly

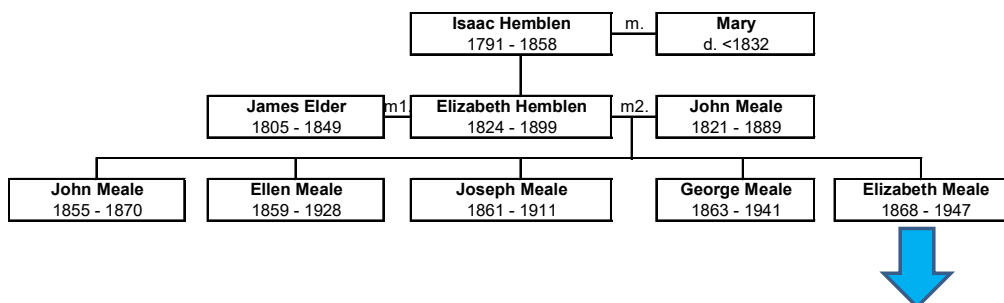

Elizabeth was the youngest child of John Meale and Elizabeth Hemblen, and she was born on 19 March 1868 at Waiwera. She married Thomas Kelly on 9 February 1891 at Auckland, and had nine children. Thomas was possibly born at sea of Irish parents, as he arrived in New Zealand as a six week old baby.

Thomas Kelly died at Cambridge on 9 February 1927, aged 69 years, and is buried in the Hautapu Cemetery. Elizabeth lived for an additional twenty years and died at Cambridge on 29 August 1947. She too is buried in the Hautapu Cemetery.

The known descendants of Thomas and Elizabeth Kelly are as follows -

1. Elizabeth MEALE (b.19 Mar 1868-Waiwera, New Zealand; d.29 Aug 1947-Cambridge, New Zealand)

sp: Thomas KELLY (b. Abt 1858-Dublin,Ireland; m.9 Feb 1891; d.9 Feb 1927-Cambridge, New Zealand)

2. Kathleen KELLY (b.7 May 1892-Mt. Roskill, Auckland, New Zealand; d.31 Dec 1969-Whangarei, Northland, New Zealand)

2. William Thomas KELLY (b.28 Nov 1893-Mt. Albert, Auckland, New Zealand; d.23 Oct 1918-France)

2. Frederick John KELLY (b.24 Aug 1895-Pt. Chevalier, Auckland, New Zealand; d.25 Aug 1968-Auckland, New Zealand)

2. Albert Joseph KELLY (b.31 Jul 1897-Pt. Chevalier, Auckland, New Zealand; d.8 Apr 1989-Oamaru, New Zealand)

sp: Muriel Freda STEPHENSON (b.24 Mar 1900; m.3 Nov 1920; d.14 Aug 1985-New Zealand)

3. Doris Muriel Elizabeth KELLY (b.31 Dec 1920-New Zealand; d.21 Jul 1997-New Zealand)

sp: Arthur Alfred GOODMAN (b.25 Nov 1919; m.1944 (Div); d.4 Sep 1992-New Zealand)

sp: Frederick James ROBERTSON (b.14 Oct 1920; m.1956; d.2 Aug 2013-New Zealand)

3. William Albert KELLY (b.18 Apr 1922; d.25 May 1989-New Zealand)

sp: Ellen Marjorie IRELAND (b.31 Aug 1923; m.1945; d.2 Oct 1996-New Zealand)

3. Edward George KELLY (b.3 Sep 1923; d.25 Sep 1995-Dunedin, Otago, N.Z.)

sp: Mavora May BROWN (b.20 Jan 1929; m.1951; d.23 Mar 2016-New Zealand)

4. Lynette May KELLY (b.27 Oct 1951; d.13 Apr 2013-Dunedin, Otago, N.Z.)

- sp: Graeme STANLEY
- 4. Grant Lindsay KELLY
- 4. Laurence George KELLY (b.21 Jul 1956; d.11 Oct 1956)
- 4. Pamela Maree KELLY (b.29 Apr 1959-Mosgiel, Dunedin, Otago, New Zealand; d.16 Jul 2019-Mosgiel, Dunedin, Otago, New Zealand)
- sp: Richard Alan FERGUSON
- 3. Stanley Thomas KELLY (b.21 Sep 1924; d.27 Dec 1991-Porirua, Wellington, New Zealand)
- sp: Verna Joyce WOODCOCK (b.30 Aug 1925; m.1951; d.26 Mar 2019-Lower Hutt, Wellington, New Zealand)
- 4. Paul KELLY
- sp: Denise
- 4. Sandra Joy KELLY
- 4. Denise Erin KELLY
- sp: Tere
- 3. Gloria Mary KELLY (b.4 Mar 1933; d. 26 Jan 2018-Timaru, New Zealand)
- sp: Mervyn James BALLANTYNE (b.11 May 1930; m.1952; d. 25 May 1997-New Zealand)
- 4. Brian James BALLANTYNE (b.5 Mar 1954-Palmerston, Otago, New Zealand; d.20 Nov 1994-New Zealand)
- sp: Rosemarie IDE (b. Oct/Dec 1954-Northampton, Northampton, England)
- 4. Leslie Michael BALLANTYNE
- 4. Donna Maree BALLANTYNE
- 4. Bronny BALLANTYNE
- 3. Owen Patrick KELLY (b.12 Nov 1935; d.26 Feb 2008-New Zealand)
- sp: Hira Geraldine (b.8 Apr 1934; d.10 Nov 1995-New Zealand)
- 4. Philip Albert KELLY
- 4. Tania Lucy KELLY
- 2. Mary KELLY (b.31 Aug 1899-Mt. Albert, Auckland, New Zealand; d.19 May 1947-Cambridge, New Zealand)
- 2. Dennis George KELLY (b.5 Jan 1901-Mt. Albert, Auckland, New Zealand; d.15 Sep 1982-Cambridge, Waikato, New Zealand)
- sp: Elizabeth MCDEVITT (b.11 Feb 1898-New Zealand; m.3 Jun 1929; d.20 Oct 1983-Tokanui, Waikato, New Zealand)
- 3. Maureen Margaret KELLY
- sp: Graham Dennis MARWOOD (m.1954)
- 3. Pauline Agnes KELLY (b.11 Mar 1933; d.26 Mar 2018-New Zealand)
- sp: Graham MORSE
- 4. Maureen MORSE
- sp: Grant
- 4. Michael MORSE
- sp: Ann
- 4. Donna MORSE
- sp: Ian
- 4. Kelly MORSE
- sp: Lynette



- 4. Rosanne MORSE
  - sp: Robb
- 3. Peter Dennis KELLY
  - sp: Mary FLYNN
    - 4. John KELLY
    - 4. Suzanne KELLY
    - 4. Angela KELLY
- 3. Bryan Patrick KELLY
  - sp: Joy
    - 4. Shane KELLY
    - 4. Tracie KELLY
    - 4. Steven KELLY
- 2. Ellen Elizabeth KELLY (b.23 Jul 1904-Waiuku, New Zealand; d.29 Jul 1983-Whangarei, Northland, New Zealand)
  - sp: James Penman MOYLE (b.23 Jul 1902-New Zealand; m.23 Jul 1928; d.27 Sep 1966-Whangarei, Northland, New Zealand)
    - 3. Patricia MOYLE
      - sp: Raymond MILLER
        - 4. Glenn MILLER
        - 4. Brett MILLER
    - 3. Robert MOYLE
      - sp: Judy
        - 4. Kelly MOYLE
        - 4. Michael MOYLE
    - 3. Edward MOYLE
      - sp: Robyn
- 2. Dorothy KELLY (b.9 Sep 1905-Waiuku, New Zealand; d.10 Apr 1952-Cambridge, New Zealand)
  - sp: Alfred Ernest JAMIESON (b.7 Oct 1894-Taranaki, New Zealand; m.10 Jun 1925; d.22 Oct 1961-New Zealand)
    - 3. Doreen JAMIESON (b.17 Oct 1926; d.5 Nov 2013-Hamilton, New Zealand)
      - sp: Francis Douglas PREECE (b.13 Mar 1921-Salford, Greater Manchester, England; m.15 Apr 1950; d.27 May 2004-Hamilton, Waikato, New Zealand)
        - 4. Dorothy Ann PREECE
        - 4. Lorraine Elizabeth PREECE
          - sp: Kenneth Albert WATCHORN
        - 4. Patricia Irene PREECE
        - 4. Michael Francis PREECE
          - sp: Katherine Jennifer HUMPHREYS
  - sp: Archibald Smith Campbell MCCAIG (b.25 Nov 1919; m.21 Mar 1970; d.5 Oct 1984 -New Zealand)
    - 3. Winifred JAMIESON (b.25 Oct 1927-Cambridge, New Zealand; d.28 Sep 2005-Tauranga, New Zealand)
      - sp: Leonard Charles CROOT (b.22 Aug 1927; m.1952; d.29 Jul 1992-New Zealand)
        - 4. Gary CROOT
        - 4. Lincoln CROOT

- 4. Ian CROOT
- 3. Vivian Alfred JAMIESON (b.27 Mar 1930; d.4 Oct 2001-Rotoo-Rangi, Cambridge, New Zealand)
  - sp: Diana Grant MCDONALD (b.19 Sep 1932; d.18 Apr 1989-New Zealand)
    - 4. Jane Margaret JAMIESON
      - sp: Mike
    - 4. Mary Catherine JAMIESON
    - 4. Alfred John JAMIESON
    - 4. Edward Ian JAMIESON
      - sp: Pauline
    - 4. Andrew Robert JAMIESON
      - sp: Bronwyn
    - 4. Alison Clare JAMIESON
      - sp: Brendon
    - 4. Christine Elizabeth JAMIESON
- 3. Noeline Elizabeth JAMIESON (b.3 Apr 1934; d.28 Nov 2020-Cambridge, Waikato, New Zealand)
- 2. Randolph Joseph KELLY (b.18 Apr 1909-Otaua, New Zealand; d.20 Apr 1982-Hamilton, Waikato, New Zealand)
  - sp: Juanita Dagmar JONES (b.3 May 1912-Kings Norton, Warwickshire, England; m.1944; d.5 Mar 1991-Hamilton, Waikato, New Zealand)

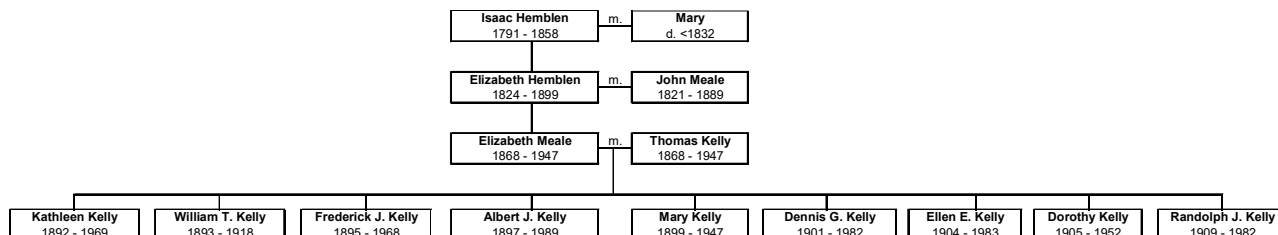

## Chapter 12 – Vivian John Cosgrave and Justine Brady

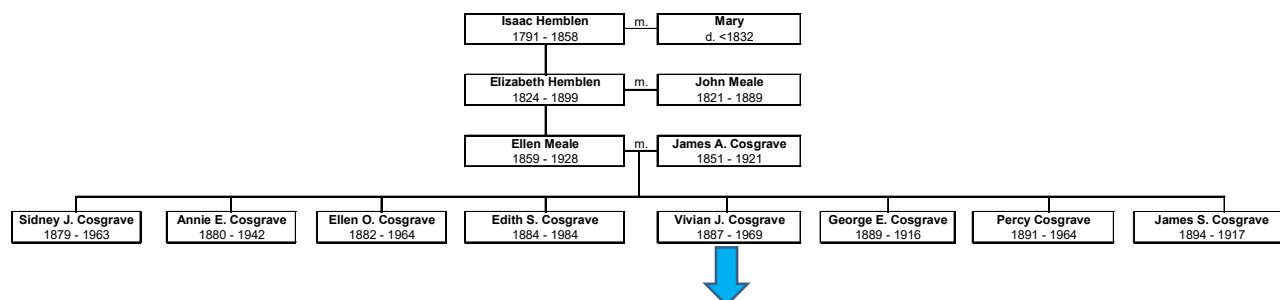

Vivian John Cosgrave (my grandfather), the fifth child of Ellen Meale and James Alexander Cosgrave, was born at Upper Waiwera on 1 May 1887. Initially he worked on the family farm, but at 28 years old, he joined New Zealand Police on 29 March 1915 as a constable, and was posted to Wellington. On 10 November 1915 he married Justine Ursula Brady in the Roman Catholic church at Howick, Auckland, and the couple settled into life together in Wellington, living at 228 Tinakori Road, and it was here that all five of their children were born.



(l-r) Viv, Harry, Justine, Jim, Vivian, Noeline Cosgrave abt. 1940.

Vivian's first promotion in the police force was to a sole-charge constable position in Levin in the mid-1920s, but by 1930 he had been transferred to Hunterville. The Truth newspaper of 3 April 1930 reports that "*VIVIAN JOHN COSGRAVE is the law in Hunterville and he does his job well. While he would always prefer to do a man a good turn he does not allow his kindly nature to interfere in the discharge of his duties. As clerk of the court he wields his pen and conducts his cases well, while his guiding hand controls a wide district. "Cossy" loves football and he may often be heard instructing*

*the young men in the rudiments of the game. He knows its "laws" and the boys listen well*"<sup>xiii</sup>.

From Hunterville, the family moved back to Wellington in 1935, living again on Tinakori Road, but this time at number 174, as Vivian was promoted to Police Sergeant. In 1939 he was transferred to Wanganui, in December 1940 to Taumaranui, and in 1944 to his final appointment, in Foxton.

Vivian retired in Foxton in 1955 after serving his 40 years with New Zealand Police. Justine had died on 2 May 1950 and is buried in the Foxton cemetery. In the mid-1960s Vivian moved to Wellington, where he lived with his daughter Noeline, until his death on 16 October 1969. He is buried in the Foxton cemetery, next to his wife and their two unmarried children.



Grave of Vivian, Justine, Noeline and George Cosgrave – Foxton, NZ.



**George S. & James E. Cosgrave (abt. 1922).**

As mentioned at the beginning of this chapter, Vivian and Justine Cosgrave raised five children, four boys and one girl. Their eldest child was my father, James Edward Cosgrave, who was born in Wellington on 9 January 1917. His life will be covered in detail in the next chapter.

The second child of Vivian and Justine Cosgrave was George Steele Cosgrave, whose life will be covered in chapter 16.

Noeline Catherine Cosgrave was the third child and only daughter of Vivian and Justine Cosgrave. Noeline was born 31 December 1920 in Wellington. She was at secretarial college in Wanganui when her father was transferred to Taumaranui, and Noeline boarded with a local Wanganui family until her studies were completed. Noeline worked in an administrative role for the New Zealand government until retirement, and she then worked for a firm of architects.



**Noeline Cosgrave.**

Noeline did not marry and she cared for her father in his later years. When her property on Kemp Street, Kilbirnie became too much for her to look after, she moved into an apartment on William Street, where she lived until moving to a care home when her health failed. Noeline died at 95 years of age on 28 September 2015 and is buried with her parents in the Foxton Cemetery.

Vivian John junior (Vic or Viv) was born 20 January 1923. Viv (as I knew him) joined the Royal New Zealand Air Force (70987), and was a career officer. In the 1967 New Year's Honours he received an M.B.E. (Military Division). Viv retired from the Air Force as a Warrant Officer.

He married Audrey June Martyn in 1951 and they had two sons – Gary Martyn and Paul Edward. Both sons emigrated to Australia, and after Viv retired, he and Audrey also moved to Australia, settling in Brisbane.

Viv was hit by a car while crossing the road, and died 11 April 2007. Audrey died 22 January 2014. Both are buried in Nerang, Queensland.

The youngest child, Henry Timothy (Harry) Cosgrave was born 4 May 1924. After high school Harry joined the Royal New Zealand Air Force (71779) and spent a portion of his career stationed in Singapore.

Harry married Kathleen Marjorie Jury in 1947 and the marriage produced four children – Karyn Justine, Antony John, Peter Christopher and Michael David.

He retired to the Air Force Officers Reserve List as a Flight Lieutenant on 17 February 1969 and was officially retired four years later. Harry then worked for the City of Porirua, and died in Rotorua on 25 April 1987. His wife, Kathleen, died 20 October 2010 in Wellington.



**Viv Cosgrave & Audrey Martyn wedding 1951.**



**Harry Cosgrave & Kathleen Jury wedding 1947.**

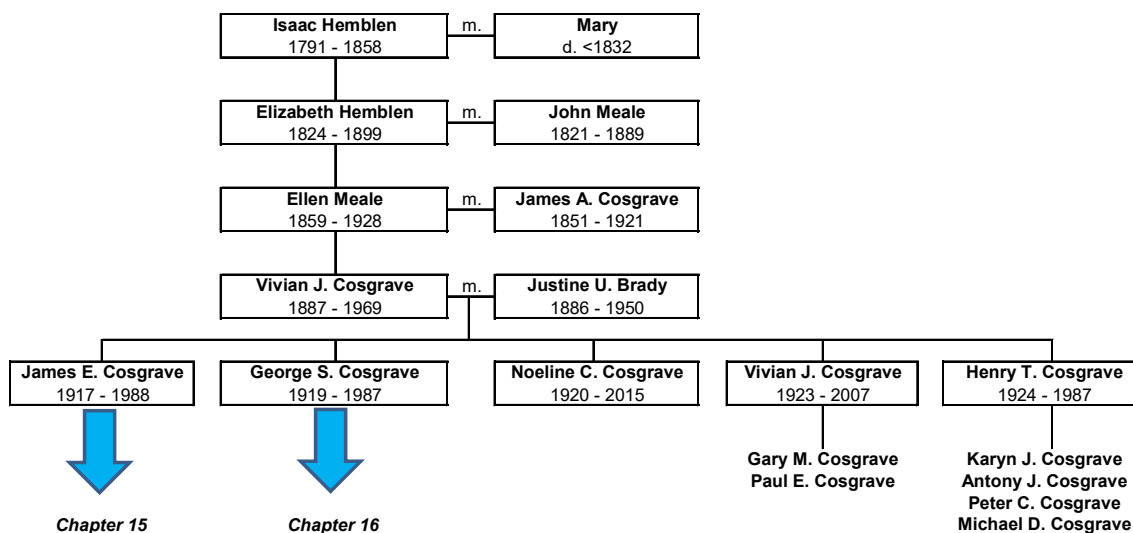

## Chapter 13 – George Edward Cosgrave

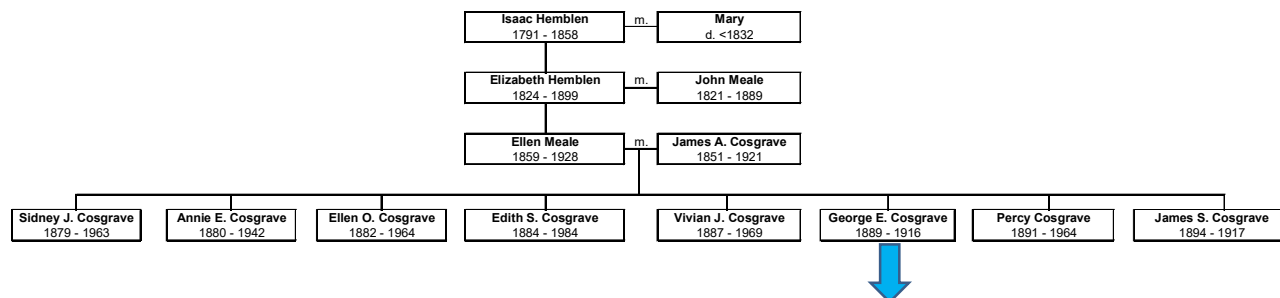

George Edward Cosgrave, like his brother, Vivian John, became a policeman. He was sworn in on 24 November, 1911, and was described as being 6 ft. and 1/4 inch tall, with fair hair, fair complexion, brown eyes, and Presbyterian by religion. On 8 July, 1915 he resigned from the New Zealand Police Force, and on 10 August 1915 he joined the Australian Army under the name George Edward Wells (3550). All of the other information in his attestation appears to be correct, so it is not clear why he left a protected job in New Zealand, changed his name, and fought in the Australian Army. On his attestation, George named his sister, Mrs. Annie Jamieson, as his next of kin.

He sailed from Sydney on 5 October 1915 and joined the 11<sup>th</sup> Reinforcements of the 1<sup>st</sup> Battalion at Tell El Kebir, Egypt on 6 January 1916. Tell El Kebir was a training centre for the Australian Imperial Force reinforcements, and whilst there, George was promoted to Sergeant on 14 February 1916. He was only in Egypt for two and a half months, before embarking at Alexandria on 22 March 1916, and arrived in Marseilles, France on 28 March.



George's unit was deployed to Flanders in Northern France, and on 29 June 1916, he suffered a shrapnel wound to his right shoulder, requiring his transfer to a rest station at Trois Arbres, near Bailleul, to have it treated. On 7 July he rejoined his unit and 5 days later, on 12 July 1916, George was awarded the Military Medal, a decoration awarded to non-commissioned officers and other ranks, for "acts of gallantry and devotion to duty under fire". The citation reads - "*Near Gailly, France on the night of 29/30<sup>th</sup> June 1916 he saw that the tape was only laid and arranged for a raiding party. He then escorted prisoners through the wire and afterwards, although exhausted, remained behind and assisted to bring in the body of Sergeant Downer and Lieutenant Prior (wounded) on these occasions being under heavy fire*".

On 31 July 1916 George was again evacuated to hospital, this time with influenza. He was back with his unit on 21 August, but just over two weeks later, on 6 September, he was again sent to hospital, suffering with varicose veins. He stayed in hospital for almost two months, and was discharged on 29 October, rejoining his unit on 3 November.





Sadly, on 5 November, just two days after rejoining his unit, George was identified as Missing In Action, and on 7 March 1917 was officially declared as Killed In Action. George was buried in a bayonet trench cemetery at Gueudecourt, 2 ¾ miles S.S.W. of Bapaume, Pas de Calais, along with 18 other soldiers of the 1<sup>st</sup> Australian Infantry Battalion who died the same day.

**G.E. Cosgrave.**

After the war ended, the bodies of the soldiers buried at Gueudecourt were exhumed and reburied at the Grevillers British Cemetery, one mile West of Bapaume. During this transition, the identity of the individual bodies was lost sight of, and so George's exact grave location is not known.

In addition to the Military Medal, George also received, posthumously, the British War Medal, the 1914-1915 Star and the Victory Medal.



**British War Medal.**



**1914-1915 Star.**



## Chapter 14 – James Steele Cosgrave (jnr.)

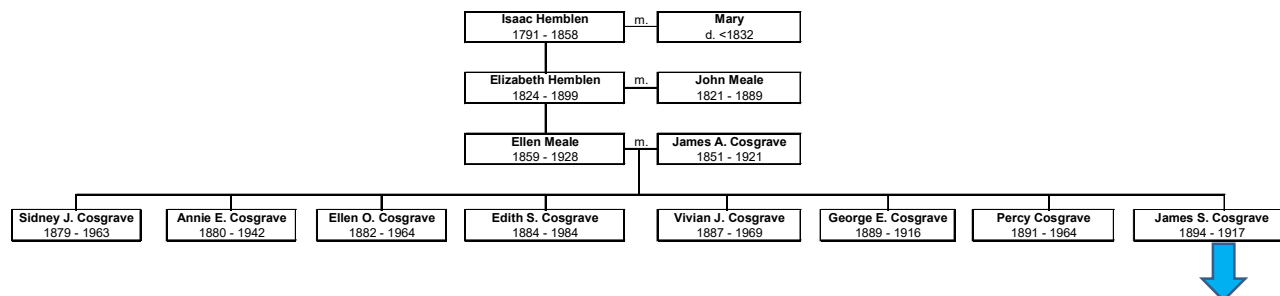

James Steele Cosgrave (junior), the youngest child of James Alexander Cosgrave and Ellen Meale, was born 16 July 1894 at Upper Waiwera, New Zealand.

When World War One broke out, James was working as a bushman in Hawera, but at 20 years of age he travelled south to Palmerston North and on 26 August 1914 he attested for the New Zealand Expeditionary Force, and was assigned regimental number 2/296.



J.S. Cosgrave.

As part of the 1<sup>st</sup> battery of the 1<sup>st</sup> brigade, James became a driver with the New Zealand Field Artillery, and on 23 September 1914 he embarked for Egypt, where he served for the next 201 days. Whilst in Egypt, James displayed a somewhat devil may care attitude and was punished for creating disturbances in the mess hall and after lights out, being drunk on duty, insolence to an N.C.O, and for disobeying orders. Perhaps he was just bored, as once he was transferred to Gallipoli on 12 April 1915, he seemed to stay out of trouble. James survived 173 days in Gallipoli, before being transferred back to Egypt, where he was stationed for another 187 days. His only issue whilst in Egypt was a month and a half spent in hospital due to an abrasion of the knee. He embarked for Europe on 6 April 1916.

After serving six months in Europe, James was appointed acting Bombardier, and on 1 December 1916 was officially promoted to the rank of Bombardier. In early January 1917, he was granted leave in England, and it seems that along the way he picked up a sexually transmitted disease, as he was admitted to the V.D. section of the military hospital at Codford on 9 January 1917.

On 24 March 1917 he returned to his unit in Belgium, rested and with a clean bill of health. But on 2 May he was back in hospital with chicken pox, which kept him out of the action for three weeks. On 24 May 1917 he rejoined his unit in the field and one month later, on 30 June 1917, James was appointed temporary Corporal, when temporary Corporal (2/1002) S.J. Goodyear was promoted to Sergeant. James was promoted to the rank of Corporal on 22 September 1917, when Corporal (2/489) H. Deridder opted to revert to the ranks.

His unit was serving on the Ypres front at the time, and 12 days later, on 4 Oct 1917 Corporal (2/296) James Steele Cosgrave was killed in action, just 11 months after the death of his brother, George Edward Cosgrave, 100 Km away. He is buried at the Divisional Cemetery, Dickebusch Road, near Leper, Belgium.



James Steele Cosgrave earned the British War Medal, the Victory Medal and the 1914-1915 Star for his service to King and Country.



**James S. Cosgrave's 1914-1915 Star.**

## Chapter 15 – James Edward Cosgrave and Kathleen Veronica Sherlock

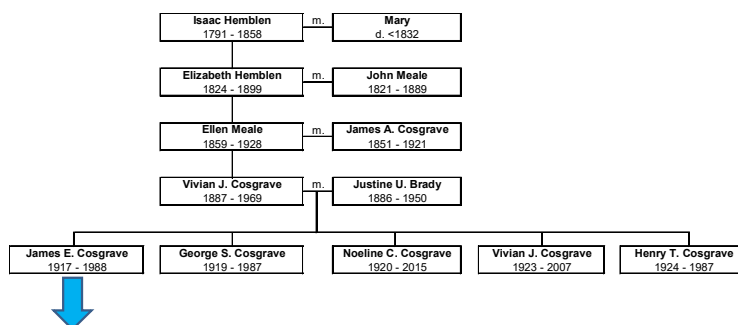

New Zealand had been at war for a little over a year, when Vivian John Cosgrave married Justine Ursula Brady on 10 November 10 1915. Vivian's brothers, James and George, had signed up for military service and were already serving overseas, so they missed the celebration.

It was a difficult time for New Zealand, having suffered heavy losses in the Gallipoli campaign, so there would have been much joy, when just a few months later, Justine announced that she was pregnant with their first child, a son, who was born in Wellington on 9 January 2017. As their first son, in keeping with the Irish naming tradition, he was named James after his paternal grandfather (James Alexander Cosgrave), and Edward after Vivian's brother, George Edward Cosgrave, who was missing in action in France at that time.



Justine, James & Vivian abt. 1920.

The family of three lived at 228 Tinakori Road, and were soon joined by three more sons and a daughter – George Steele Cosgrave (1919); Noeline Catherine Cosgrave (1920); Vivian John Cosgrave (1923); and Henry Timothy Cosgrave (1924).

In November 1926, Vivian was transferred to Levin, but only 2 years later in January 1929, he was transferred to Hunterville, a sole-charge posting for a senior constable, and the family lived at the police house on Milne Street (State highway 1) in Hunterville.

Nothing is known of James's early education, but he likely attended the local Hunterville school. In 1932, when he was 15 years old, his parents decided to give him the opportunity to attend a better high school than was available in the Hunterville area, and enrolled him as a boarder at St. Patrick's College, Silverstream, in the Hutt Valley. At Silverstream James played rugby in the 7<sup>th</sup> and 8<sup>th</sup> fifteen so was definitely not a star sportsman. But he did excel at rifle shooting, being considered a first class shot, with a score of 87, just 3 points short of the marksman rating.

His academic prowess may not have been as great as his shooting ability, as he remembered being caned (corporal punishment with a bamboo cane) for getting his homework wrong. It is likely that it was at Silverstream that James also developed his lifelong interest in radio and electronics.

James did not stay at Silverstream beyond one year, opting instead to leave high school and return home to Hunterville, where he worked for a local baker. Here he developed an ability to

make excellent scones and other baked goods, learning to adjust the mixture based on the “feel” of the dough. His scone making prowess was much appreciated by his family in later years.

In March 1935, Vivian Cosgrave was promoted to the rank of Police Sergeant, and the family returned to Wellington. James moved back to Wellington with the family and in August 1936 he joined New Zealand Railways as a Guard. Initially, Jim (as he was now known) worked on the Wellington suburban trains, and in June of 1937 he was responsible for organizing the sound system for the opening of the new Wellington Railway Station. He later worked on the main rail lines, being recorded as a Tablet Porter in 1938, in which role he worked on the Wairarapa line and the North Island Main Trunk line.

From Wellington, Jim was transferred to Tokomaru in early 1939, where he stayed at the Guy’s boarding house on Rata Street, Tokomaru. Violet Guy, the proprietor’s daughter, was something of a matchmaker and introduced Jim to Kathleen (Kath) Sherlock. He and Kath hit it off, but on 3 September 1939 New Zealand declared war on Germany and their lives changed significantly.

On 29 December 1939 Jim attested for the Royal New Zealand Air Force at Weraroa, Levin, and by late January 1940 he was in training as a Wireless Operator at Wigram Air Force Base, near Christchurch.

Jim requested permission from the Air Force, to marry Kath, and on 17 February 1940, that request was approved. Jim purchased an engagement ring, which was mailed to Kath on 14 April, and both families were informed of the planned wedding. In late July, with many of his mates being transferred overseas, Jim was transferred to Ohakea Air Force Base, near Bulls. Perhaps this was a compassionate move, given the planned wedding.



**Jim Cosgrave & Kath Sherlock  
Wedding Photo.**

Jim and Kath were married at St. Patrick’s Roman Catholic Church in Palmerston North on 3 September 1940. After the wedding, Kath remained living with her mother and sisters, who around this time had moved into Palmerston North and bought a house at 56 Roy Street, and Jim returned to the Air Force.

Jim continued to be stationed at Ohakea, apart from a short stint at Milson in 1942 (where he was promoted to Corporal), until he was transferred to Whenuapai, near Auckland in September 1943. After only a few days at Whenuapai, he was transferred to Waipapakauri and then on to Ardmore. While Jim was stationed at Ardmore, he was promoted to Sergeant, and Kath gave birth to their first child, Margaret Ann Cosgrave. Jim was not home for the birth, but did get leave soon after, to see his baby daughter.

On 26 October 1944 Jim was transferred to Lauthala (Laucala) Bay on the island of Viti Levu in Fiji. New Zealand had been given responsibility for air reconnaissance around Fiji, and this was to be done with flying boats. The base at Lauthala Bay was developed to house the Catalina and Sunderland flying boats which fulfilled this mandate. Jim told stories of the flying

boats landing two-man teams at remote islands, to spend weeks at a time, observing the sea in the area, looking for enemy ships and submarines. The radio operator was crucial to this work, as radio was the only means of communications with base. He claimed that the crews lived primarily on whiskey and bananas, to augment the military rations provided.

Soon after V.E. Day (8 May 1945) Jim was hospitalised for a short period with Dengue Fever, from which he recovered well.

The war officially ended with the surrender of Japan on 15 August 1945, but No. 6 Flying Boat Squadron was to stay in Fiji until their work could be transitioned to the civil aviation authority. Flight Sergeant (391966) James Edward Cosgrave returned to New Zealand in December 1945, after an 8 ½ hour flight on a Catalina from Fiji. He was officially discharged from the Air Force on 8 February 1946, and was entitled to wear the 1939-45 Star, the Pacific Star, the Defence Medal, the War Medal, and the N.Z. War Service Medal.



**18 Haydon Street (1946).**

In 1946 Jim and Kath bought a house at 18 Haydon Street, Palmerston North, which remained their home until their deaths. The house was built largely with recycled materials as access to new building material was still restricted due to the war. In 1958-59, the wash-house (complete with wood-fired water heater) was removed and a small addition was made to the rear of the house. At that time, the recycled roofing iron was also replaced.

Jim and Kath Cosgrave had 4 children in total, as listed below, but the second born lived only a few hours –

- Margaret Ann Cosgrave
- Vivienne Mary Cosgrave, born 5 June 1947; died 6 June 1947
- Patricia Ursula Cosgrave
- James John Cosgrave (the author)

After the war Jim hoped to open a neighbourhood convenience store (a dairy in New Zealand parlance), but it seemed that the local co-operative society was granted all of the permissions to build, with individuals left out in the cold. At a public meeting on the topic, Jim stated that he would walk bare-footed over broken glass to Awapuni (the other side of town) and carry his groceries home in a sack before setting foot in a co-op store, a pledge that he stuck to throughout his life.

Jim worked at Coles, a music and electrical shop on The Square in P.N., until the mid-1950s when he set up his own business, Communications Services, in the rapidly expanding field of mobile radio communications. Jim did the technical work, and Kath handled the office side of the business.

Running his own business as a one-man show, Jim did not take holidays, but managed the occasional long weekend trout fishing with friends and relatives. Jim was on good terms with Monsignor Cullen, who had a rustic cottage on the southern shores of Lake Taupo at Pukawa.



**Monsignor Cullen's Cottage at Pukawa.**

Family holidays were spent at Monsignor Cullen's cottage, and involved Jim driving the family to Pukawa on a Friday night, staying the weekend to ensure that all was working well (generator for electricity, water pump, etc.), do a little fly fishing in the evening, and then driving home for the work week. He would return the following weekend to pick the family up. At least once during the week, Kath would make the trek up the dirt track to the road (often with one of the younger children in tow), hitchhike into Tokaanu, buy essential groceries and hitchhike back to Pukawa.

The British company, Pye Telecommunications Ltd., had begun selling their radio-telephones (two-way radios in North American parlance) in New Zealand in 1951, and these products became popular for mobile communications by emergency services and other fleet operators that needed to be in instant touch with their field staff. Communication Services became a regional dealer of Pye Electronics in New Zealand, a relationship which endured until the business was wound up after Jim's death.

In the 1950s, telephone, telegraph and radio communication systems in New Zealand were primarily provided by the Post Office and it was illegal to compete with the Post Office for telecommunications revenues. However, technology was moving forward faster than the Post Office's ability to deliver service, and organizations were permitted to provide radio communications facilities for their own use where no Post Office service existed.

Communication Services became a leader in providing these systems to regional Power Boards (electricity distributors), and Catchment Boards (water resource and control organizations), municipalities, vets, taxis, etc.

As mobile communication system use spread to trucking and other industries, the Post Office could not keep up with the demand for service, and they began licensing User Associations (groups of organizations that required radio services in a geographical area) to provide services for their members.



**Communication Services new workshop (abt. 1960).**

Communication Services was heavily involved in the engineering and maintenance of such systems throughout the Wairarapa and Hawkes Bay.

In the mid-1980s, Jim was diagnosed with leukemia, a diagnosis that was in common with several others involved with early radar systems during the war, suggesting that there may be a link between their wartime activities and their health. Around this same time, cellular mobile telephone service was introduced in New Zealand (1987), and this service rapidly overtook the traditional mobile communications services. Jim worked with mobile communications equipment from its war time beginnings, through its heyday, and the beginning of its decline, before passing away at the Palmerston North Public Hospital on 30 June 1988 at 71 years of age. Kathleen lived on for ten more years, and died peacefully at home on 23 April 1998 at the age of 82 years. Both are buried in the Kelvin Grove Cemetery in Palmerston North.

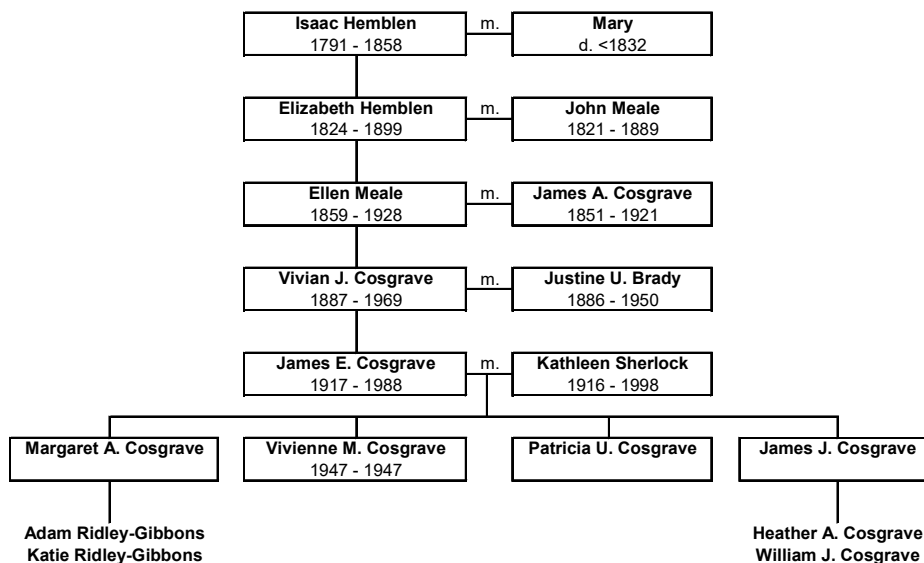



## Chapter 16 – George Steele Cosgrave

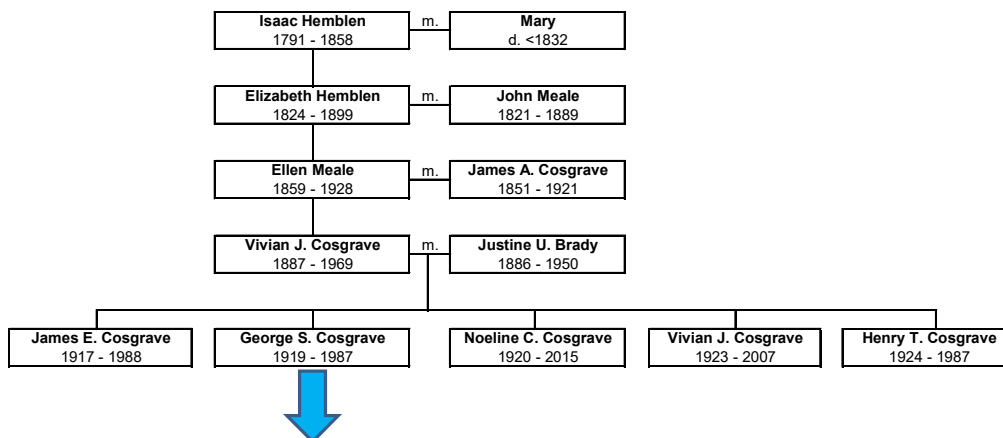

The second child of Vivian and Justine Cosgrave was George Steele Cosgrave, who was born 24 March 1919. He attended Hunterville School, Marton District High School (1933-1934) and St. Patrick's College, Wellington (1935-1936). After leaving high school, George joined the civil service, working in the Industries and Commerce Department.

The Second World War put his career on hold, as on 29 October 1940, at the age of 21, George joined the Royal New Zealand Air Force, as a Leading Aircraftman (Airman Pilot). He underwent basic training at Harewood, was remustered as an Air Observer in Levin, and at the end of February 1941 he sailed out of Auckland on the ship *Awatea* bound for Canada, where he underwent training as an Air Observer. The training was provided by the Royal Canadian Air Force as part of the British Commonwealth Air Training Plan.

In Canada George was stationed in Prince Albert, Saskatchewan (Air Observer School), MacDonald, Manitoba (Bombing and Gunnery School), Rivers, Manitoba (Central Navigation School), Debert, Nova Scotia (31 O.T.U.). In September 1941 he was posted to the U.K., where he worked as an instructor for the following year and a half, apart from several short postings to operations units in India and Egypt. He was promoted to Flight Sergeant on 1 June 1942, gained a temporary commission as a Pilot Officer on 12 September 1942, and was promoted to Flying Officer in March 1943.

In a letter home in December 1943 George bemoaned the fact that without more operations time he could not be promoted above the rank of Flight Lieutenant, so was hoping for a posting to an operations unit.

In February 1944 George was posted to India for ten months, where he was attached to 355 Squadron, and was promoted to Flight Lieutenant in September 1944.

On 3 January 1945 George was repatriated to New Zealand, having spent 3 years and 310 days overseas. He then served with 40 Squadron, flying throughout the Pacific. On his return to New Zealand after a flight in April 1945 George was charged with breaching Air Force regulations for bringing in 3 ½ cartons of cigarettes. This was not against Customs regulations and he had declared the cigarettes and paid the duty, but it seems he was caught up in a report by Customs of goods secreted within the aircraft and would not normally have been charged as

Customs did not enforce Air Force regulations. He received his one and only reprimand for this offense.

On 19 February 1946, Flight Lieutenant (403952) George Steele Cosgrave was discharged from active service to the Reserve A List. His commission was officially terminated on 1 June 1956. During his service, George had flown a total of 826 hours on Anson, Battle, Hudson, Wellington and Liberator aircraft.

For his wartime service, he earned the Burma Star, Defence Medal, African Star and Pacific Star.

After leaving the Air Force, George rejoined the Industries and Commerce Department of the New Zealand government on 1 April 1948, as a Clerk in Wellington. He was later posted to Melbourne and by 1950 he was the Assistant Trade Commissioner in Bombay, India. George remained in India, serving as acting Trade Commissioner for an extended period in 1952, before returning to New Zealand in early 1953.

George became estranged from the rest of the family around 1957, and died in Auckland Hospital on 23 July 1987 at 68 years of age. He is buried in the family plot at the Foxton Cemetery, with his parents and sister Noeline.



## Chapter 17 – DNA Testing

The foregoing chapters have identified many of the descendants of Isaac Hemblen, born circa 1789 in Dyrham, Gloucestershire, based on a combination of public records and family stories and letters. But it would be nice to be able to confirm the validity of the research.

Autosomal DNA testing, through companies such as Ancestry, 23andMe, My Heritage and FamilyTreeDNA, is of huge benefit to genealogists in confirming familial connections identified by researching the paper trail of our ancestors. If two people who have well-researched family trees, which identify a common ancestor, also share autosomal DNA, and if there is no other obvious ancestral connection, then it is highly likely that the identified common ancestor is correct.

Through comparison of autosomal DNA results I have found several Hemblen cousins who were previously unknown to me, including descendants of all four children of Isaac Hemblen, from both of his marriages, who are known to have had descendants. So autosomal DNA testing has been instrumental in confirming my Hemblen ancestry.

The chart below shows several of the connections confirmed with autosomal DNA testing, but not all known DNA connections have been included in the chart to improve readability.

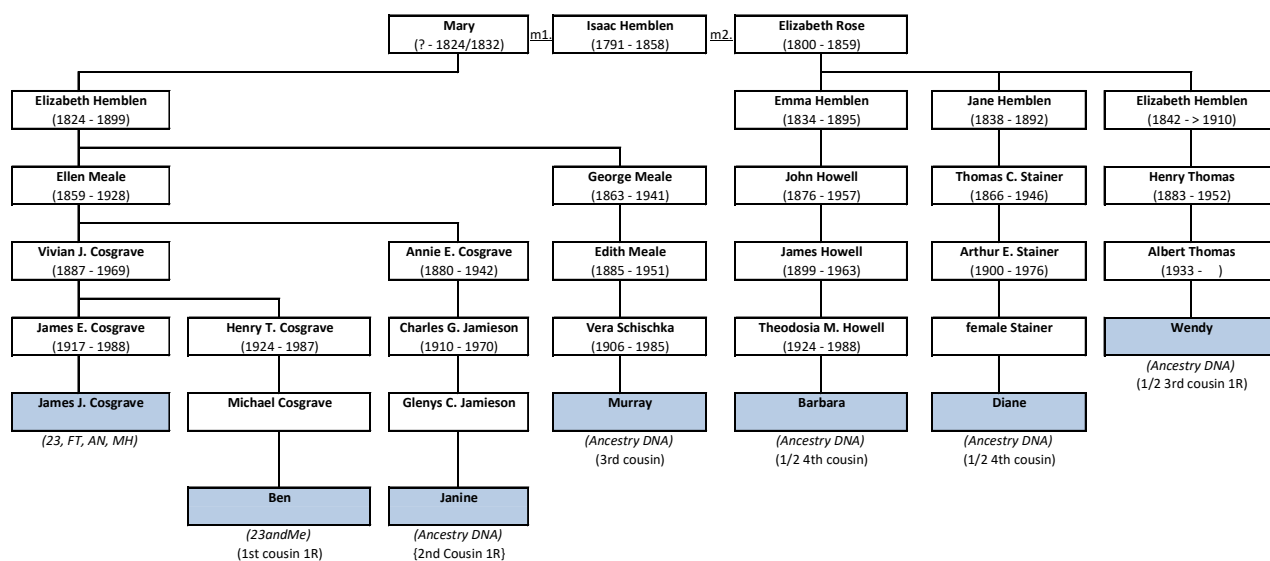

In May 2024, I identified a new autosomal DNA match, Barrie Howard, and our shared matches include several of my Meale / Hemblen relatives, suggesting that Barrie had either Fothergill (Meale) or Hemblen ancestry. Barrie's online tree shows his ancestry being primarily from Hampshire, with one great great grandparent being a Mary Ebley, born in Bath circa 1819. His tree shows no other ancestry from Bath or from Yorkshire, suggesting a Hemblen connection as being more likely than a Fothergill connection. Given the various spellings encountered for my Hemblen relatives (with and without the H), I wondered if this could be Mary Anne, daughter of Isaac Hemblen, who is listed as being 25 years old in the 1841 census. I located the marriage record of Mary and Arthur Brinkworth, which lists Mary's father as Isaac Emblym, a Stone Mason. This is not conclusive, but is strong evidence that Mary Anne Hemblen, daughter of Isaac Hemblen, married Arthur Brinkworth. Unless information to the

contrary is unearthed, I will assume this to be correct. The relationship to Barrie is shown in the chart below –

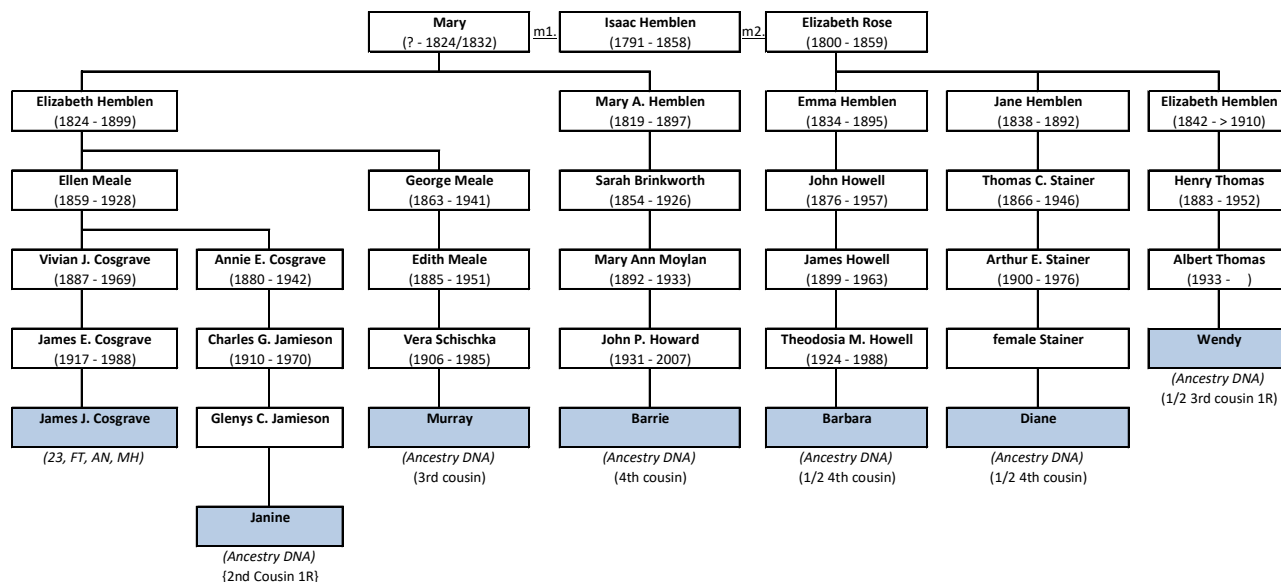

There are many other people who have taken autosomal DNA tests, with whom I share significant amounts of DNA, and with whom it appears that I may share a common Hemblen ancestor, but there is no paper trail to establish the correct relationship.

For more distant connections on the male ancestral line, Y-DNA testing can also be very useful, but with no identified male-line descendants of Isaac Hemblen, it is not possible to use Y-DNA to establish earlier Hemblen ancestry.

## References

---

- i 1851 Census of England, HO107, piece 1943, folio 135, page 53
- ii 1841 Census of England, HO107, piece 970, book 4, folio 50, page 14
- iii Bath Chronicle newspaper, 25 November 1858, page 8, column 3
- iv St. Gluvias, Cornwall, parish registers; 1844 marriages; page 125; no. 250
- v Convict Lives at the Launceston Female Factory / Lucy Frost and Alice Meredith Hodgson, editors; Hobart, 2013, ISBN 9780987144348, page 18
- vi Tasmania Libraries, CON19-1-3-page 195, Convict Description
- vii Convicts in the Colonies; by Lucy Williams; published 2018 by Pen & Sword Books Ltd., Yorkshire; ISBN 9781526718372; page 127
- viii Tasmania Libraries, CON15-1-2-pages 22,23, Convict Indent
- ix Tasmania Libraries, RGD37-1-3-page 224, number 882
- x New Zealand Herald newspaper, 25 June 1870, page 4
- xi Bath Chronicle newspaper, 20 November 1890, page 2, column 4
- xii Evening Post; Volume C1; Issue 79; 4 April 1921; Page 8; Personal Matters
- xiii NZ Truth , Issue 1270, 3 April 1930, Page 4