

The Sims of Deskford

An overview of the descendants of Walter Syme and Elspet Nichols who lived in Deskford, Banffshire, Scotland in the early 1700s



James J. Cosgrave

First published 2021 by

James J. Cosgrave

Parksville, British Columbia, Canada

First edition: April 2021

Second edition: October 2021

This publication may be freely reproduced, stored or transmitted in any form or by any means, for non-commercial purposes. Except as permitted under Canadian copyright law, this publication may otherwise only be reproduced, stored or transmitted in any form or by any means, with the prior permission in writing of the publisher.

Feedback and suggestions are welcome and should be sent to genealogyjim@shaw.ca

Front cover: Old Deskford Church and Graveyard (photo by author)

© 2021 James J. Cosgrave

Table of Contents

Introduction	4
Chapter 1 – The Early Generations	6
Chapter 2 – William Sime and Janet Laurence	7
Chapter 3 - Alexander Sim and Isabella Bartlet Paterson	9
Chapter 4 – George Innes Sim	12
Chapter 5 – John Robertson Sim	15
Chapter 6 – Jessie McDougall Sim	19
Chapter 7 – James Paterson Sim	21
Chapter 8 – Frederick William Sim (1875 – 1946)	25
Chapter 9 – Frederick William Sim (1907 – 1974)	29
Chapter 10 – DNA Testing	33
References.....	35

Introduction

Long before the introduction of civil registration of births, marriages and deaths in Scotland in 1857, the Scottish church maintained excellent records of the births and marriages within each parish, making it possible to trace a lot of Scottish ancestral lines back many generations.

The Scottish surname Sim (also found spelled as Sime, Sym, Syme, Sims, Simms, etc.) is believed to be derived from the name Simon, as in son of Simon.

This document is focussed on my wife's Sim ancestors. The story begins in Deskford Parish, in the County of Banffshire, Scotland, in the early 1700s, and is intended to provide a general overview of the many descendant branches of our Sim family tree. There will be more information on my wife's immediate family, and their story, as that is what I am most familiar with, but I hope that it will also provide a better understanding of the other descendant lines, and how we are all related.

Throughout the document, to protect their privacy, I have tried to avoid providing details of living relatives, and I apologize if this cut-off has not been perfectly executed.

This is not intended to be the final word on the Sim family of Banffshire, and I hope that over time, new information will be identified, and that people from the various descendant branches might add additional chapters to this document, expanding the story of their Sim lines.

I apologise for any errors that may have crept into the document, and I welcome any corrections, family photographs, or other feedback.

The chart on the next page shows with yellow highlight, the ancestral line that is the focus of this document.

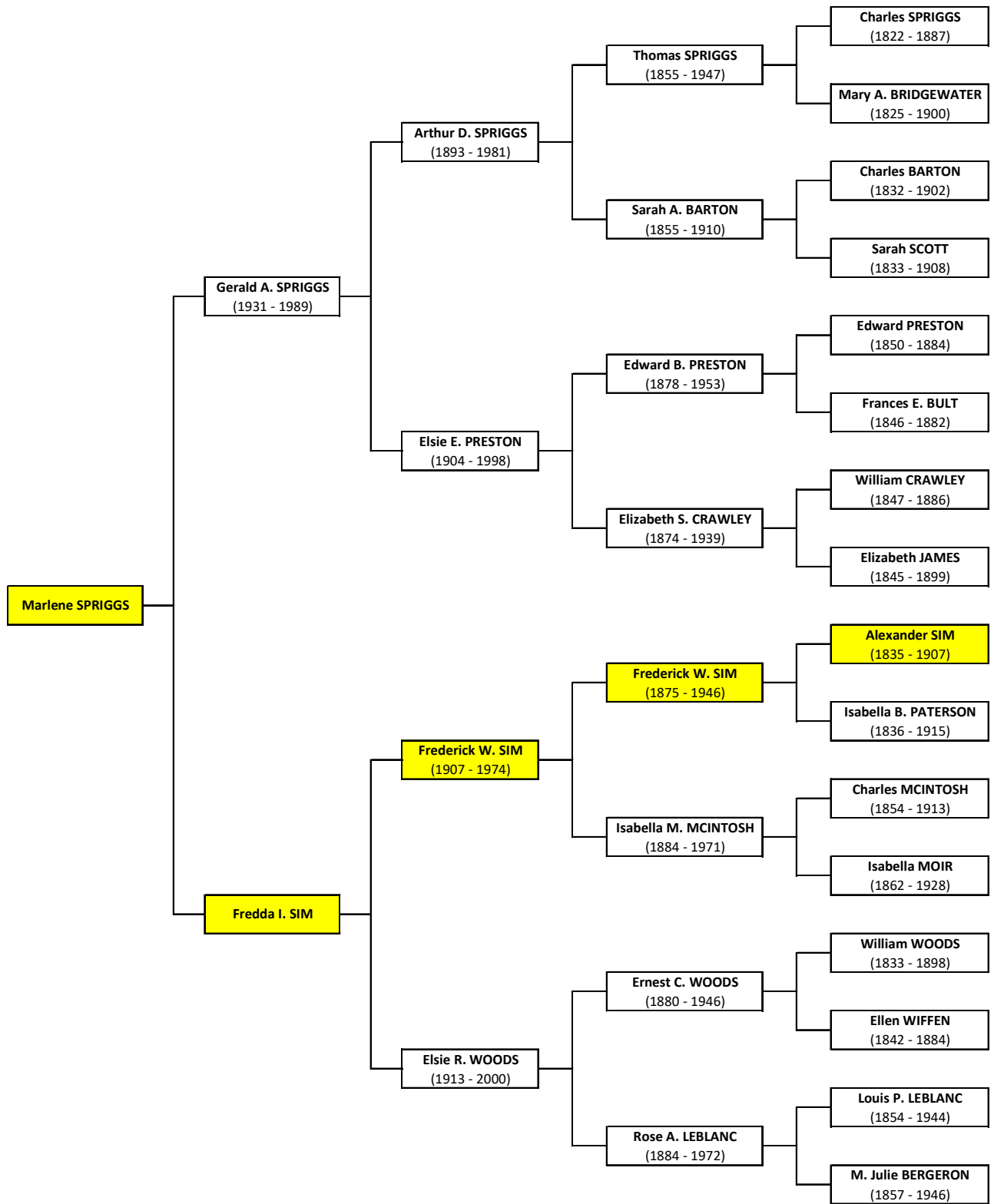

Chapter 1 – The Early Generations

The earliest record that I have found of my wife’s Sim ancestors, is the marriage of Walter Syme of Deskford and Elspet Inglis in the Parish of Fordyce, Banffshire, on 13 October 1733. Walter and Elspet had a total of eight children born in Deskford between 1734 and 1746.

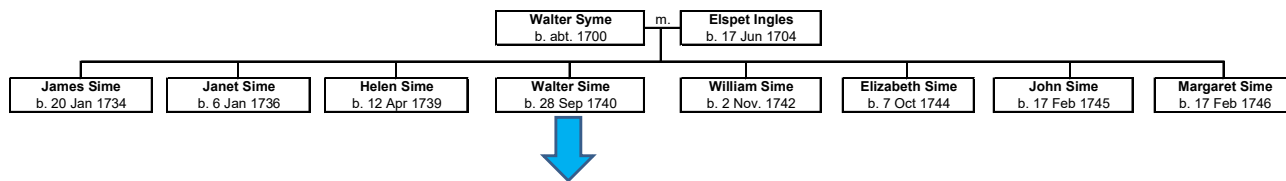

The fourth child of Walter and Elspet, was another Walter (Sime), baptised 28 September 1740 in Deskford. The Sime family were Crofters (Farmers who rented the land they farmed, often on a hereditary basis), at Berryhillock, a small community a few miles south of the Kirktown of Deskford.

Walter Sime (b. 1740) married Mary Christie of Fordyce, at Deskford on 8 November 1767, and this marriage produced seven children, the youngest being yet another Walter, born at Berryhillock on 20 March 1783.

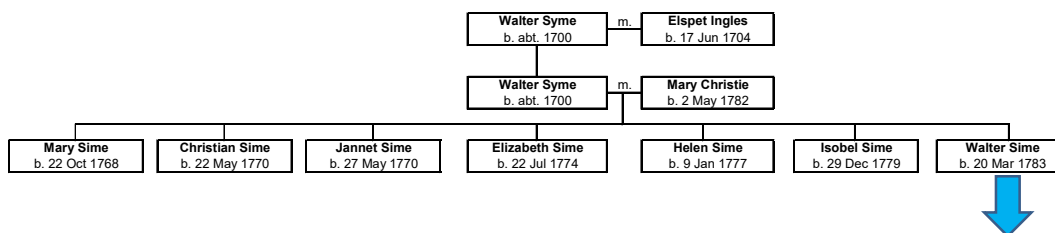

Walter Sime (b. 1783) married Elspet Dougal at Deskford on 6 July 1804, and they too had seven children, born between 1805 and 1819. I have not traced the descendant lines of these early generations in detail, apart from William Sime, born in 1815, who will be covered in chapter 2. Connection to some of these earlier Simes will be covered in the chapter on DNA Connections at the end of document.

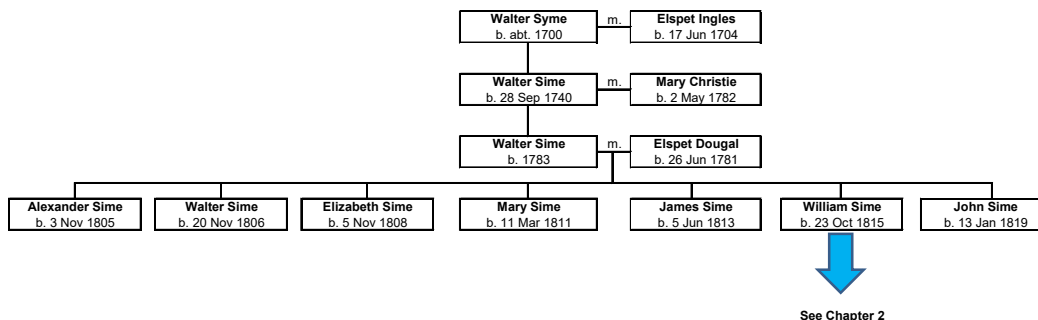

Chapter 2 – William Sime and Janet Laurence

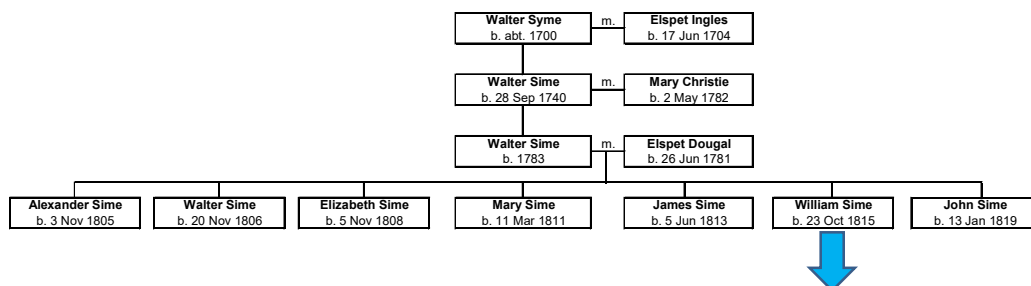

William Sime was born 23 October 1815 at Burnheads, Deskford, the sixth child of Walter Sime and Elspet Dougal. On 2 September 1834, he married Janet Laurence, a local Farmer's daughter, at Deskford. The marriage entry in the Deskford Parish Registers identifies William as William Sim (no e). His surname is recorded this way for the balance of his life, and is the surname by which his descendants are known.

The first Scottish census to list all members of each household was taken on 6 June 1841, and William and Janet Sim are found living at Croftgloy in Deskford Parish, with their sons – 5 year old Alexander and 1 year old George.

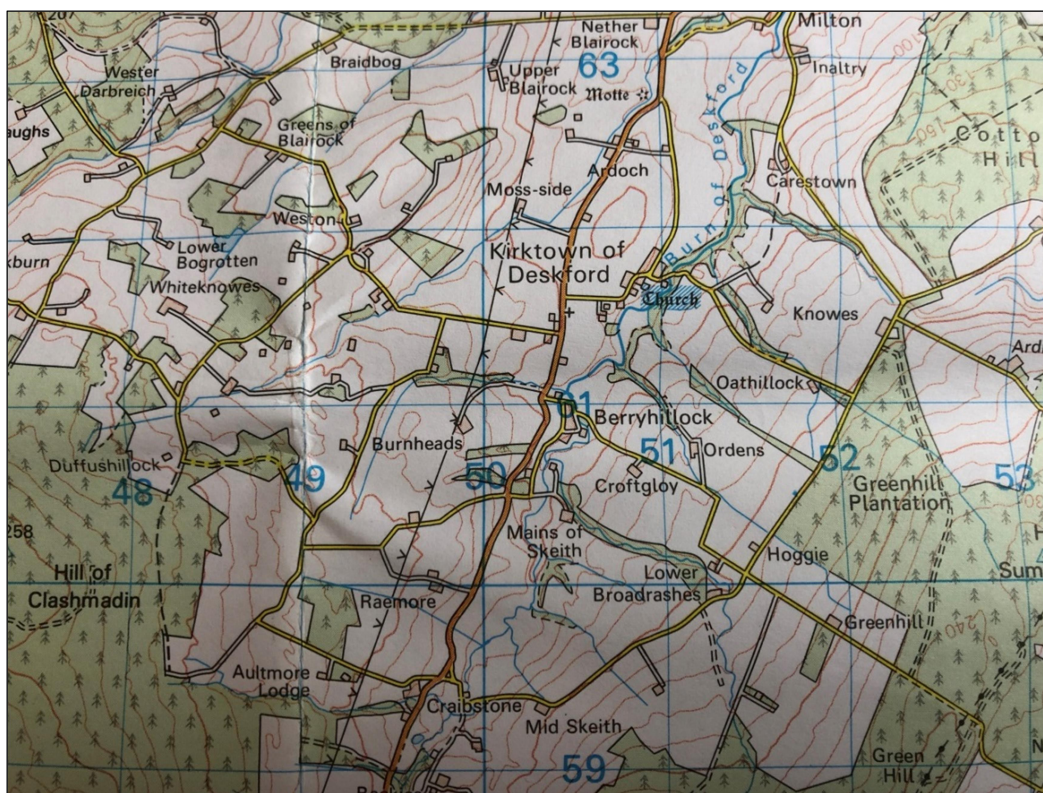

Location of Berryhillock and Croftgloy, Deskford, Banffshire.



Croftgloy, Deskford, Banffshire (1999).

In the 1851 census, William Sim is listed as a 35 year old Farmer, employing 2 labourers on his 60 acre farm, and by 1861, 45 year old William is farming 100 acres, employing 2 men and 1 boy, and the family has been joined by seven year old Jessie Sim.

William and Janet Sim continued farming at Croftgloy, until at least 1891, but spent their later years living

at Maryfield Cottage in nearby Portsoy, Banffshire. Janet died at Portsoy on 23 November 1893 at the age of 77 years. William lived for just over a year after Janet's death and he passed away on Christmas Day 1894 at Portsoy, at 79 years of age.

The three children of William and Janet Sim will be covered in more detail in the next three chapters.

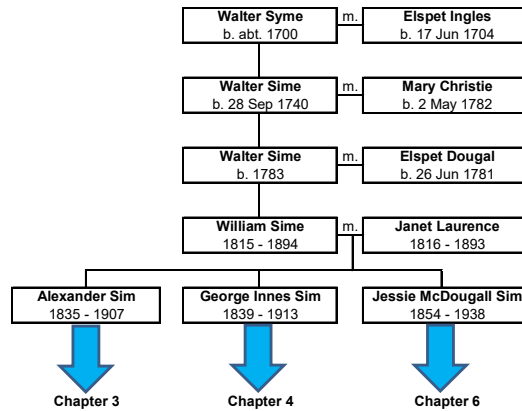

Chapter 3 - Alexander Sim and Isabella Bartlet Paterson

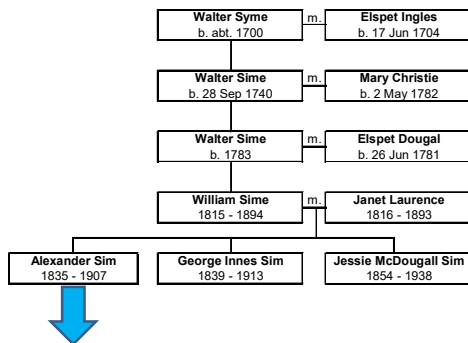

Alexander Sim, the eldest child of William Sim and Janet Laurence, was born at Croftgloy, Deskford on 15 February 1835. He was educated at the local Deskford Parish School, before working for a Solicitor in Keith, Mr. Thurburn. He then proceeded to Edinburgh to study law and after graduation he established practice in the neighbouring town of Cullen.

On 31 July 1866, 31 year old Alexander Sim married Isabella Bartlet Paterson, daughter of a ship owner in the town of Banff, at 18 Fife Street, Banff. Alexander prospered in Cullen, becoming local agent for the North of Scotland Bank, at 24 years of age. He was also local agent for the Seafield family (local landowners) and was a Notary Public. Around 1889 he became Town Clerk of Cullen, and also served on the School Board & Harbour Commission and was the collector of town taxes.

Alexander and Isabella Sim had six children as follows –

- Ann Eliza Sim, born 10 May 1867
- William Sim, born 17 November 1868
- Alexina Isabella Sim, born 11 July 1870
- James Paterson Sim, born 11 March 1872
- Jessie Sim, born 8 November 1873
- Frederick William Sim, born 13 September 1875.

Ann Eliza Sim married William Ross on 24 August 1893 and produced two children – Isobel Bartlett Henderson Ross (born 3 October 1899) and Edwin Rudd Ross (born 1906). I have not researched Ann's family beyond this point.

William Sim died on 4 September 1870, just two months before his second birthday, from Scarletina.

Alexina Isabella Sim married James Murray Young on 17 September 1895, at Cullen, and their known descendants are as follows –

1. Alexina Isabella SIM (b.11 Jul 1870-Cullen, Banff, Scotland; d.21 Feb 1941-Wellburn, Northmuir, Kirriemuir, Angus, Scotland)
sp: James MURRAY-YOUNG (b.27 Oct 1869-Old Machar, Aberdeen, Scotland; m.17 Sep 1895; d. 23 Jun 1927-Perth, Perth, Scotland)

- 2. Mary Isabella Bartlett MURRAY-YOUNG (b. Abt 1899-Hamilton, Lanark, Scotland;d.1972-Kirriemuir, Angus, Scotland)
sp: PATERSON
- 2. James Murray YOUNG (b.1902-Hamilton, Lanark, Scotland;d.24 Aug 1957-Stirling, Stirling, Scotland)
sp: Margaret BARLOW (m.1926)
sp: Nora Alice DUTHIE (m.1939)
- 2. Alexander Sim YOUNG (b.21 Jul 1905-Hamilton, Lanark, Scotland; d.24 Feb 1982-Hong Kong, China)
- 2. William Kerr Marr YOUNG (b.23 Jun 1907-Hamilton, Lanark, Scotland; d.1983-Kensington, London, England)
sp: Clara Luz Clarke SANCHEZ
 - 3. William MacDougall Murray YOUNG (b.19 Jul 1933-Lima, Peru; d.4 Jul 2011)
sp: UNKNOWN
 - 4. YOUNG (b.-Scotland)
 - 4. Hamish A. YOUNG (b.-Canada)
- sp: Frances INKIN (d. Aft 1940)
 - 3. Anthony I.M. YOUNG (b. Oct/Dec 1939-Lancashire, England)
 - 3. Angela Mary Catherine Maurice YOUNG (b.28 Oct 1941-Gloucester, Gloucester, England)
sp: Kevin F. STANDAGE (m. Jul/Sep 1964)
 - 4. Catherine STANDAGE
 - 4. Melanie STANDAGE
- sp: Lilian I. LEWIS (m. Jul/Sep 1950; d. Aft 1949)

James Paterson Sim emigrated to Canada and his family will be covered in chapter 6.

Jessie Sim married Charles Gordon MacKenzie in Banff town on 2 April 1907. I have not researched Jessie's life beyond this point.

Frederick William Sim also emigrated to Canada and will be covered in detail in chapter 7.

Alexander Sim died in Cullen on 8 January 1907, and his passing is well documented in the *Banff Advertiser* newspaper as follows - *DEATH OF THE TOWN CLERK OF CULLEN. On Tuesday the community of Cullen learned with exceeding regret of the death of Mr. Alex. Sim, Town Clerk, bank agent, and solicitor, Cullen, at the age of 73 years. Mr. Sim, who was constitutionally a strong man, caught a chill about three weeks ago. This developed into an attack of pneumonia, from which he never recovered. Deceased filled several prominent offices in the town, and his well-known figure will be much missed in the daily life of Cullen. Born at the farm Croftgloy on the Seafield estate, Mr. Sim was afterwards tenant of the farm, a tenancy he only discontinued at Whitsunday last. Mr. Sim began his education at Deskford Parish School, and afterwards entered the office of the late Mr. Thurburn, solicitor and bank agent, Keith, where he remained for several years. Proceeding to Edinburgh, he attended the classes at the university there, and in due course qualified himself as a solicitor. After a short period he returned to Keith as an assistant to Mr. Thurburn, and soon gained the confidence of his chief. Being anxious to push his way however, he while yet young, went to Cullen and commenced practice on his own account. On the withdrawal of the branch of the National Bank from Cullen about 48 years ago, the directors of the North of Scotland Bank resolved to open a branch there, and Mr. Sim, who was then only 24 years of age, was appointed agent. Under his careful management, the business prospered until the bank found it necessary to erect the present*



Alexander Sim (1835-1907).

comodious buildings on the Square. He had a remarkable faculty for overtaking a press of work, and he was also an early riser. He was local agent for the Seafield family, and was a notary public. Intimately acquainted with municipal business, the work of the town passed smoothly under his supervision and advice. His relations with a large clientele in private practice were of the most cordial character. His advice was pre-eminently disinterested and reliable, and he was held in high esteem by his brethren in the legal profession. His counsel generally was adverse to litigation. Mr. Sim took a great interest in the training of young men in his office, and several who have reached high positions in the legal and banking professions, as well as in commercial pursuits, attribute their success in no small degree to the training they received from him. About 18 years ago, on the retirement of the late Mr.

Forbes, town clerk, Mr. Sim was appointed to that office. He also acted for a long period as clerk and treasurer to the School Board, and in a similar capacity to the Harbour Commissioners, and up till two years ago he was collector of burgh taxes. The deceased was for a number of years chairman of the Parochial Board, and resigned on becoming town clerk. He was always of a bright and cheerful disposition, and was greatly respected in the district. He was married to Miss Isabella Bartlet Paterson, sister of the late Mr. Paterson, Wanford, near Banff, by whom and by a grown-up family of two sons and three daughters he is survived. Much sympathy will be extended to them in their sad bereavement. The funeral will take place on Saturday afternoon.

Alexander's will, dated 21 May 1906, left £1000 to each of his daughters, with an additional £200 for Jessie if she was unmarried at the time of his death. A codicil added on 9 July 1906 added a cash legacy to each of the four children of his son, James Paterson Sim. The balance of Alexander's estate was to be split between his five children.

Isabella, wife of Alexander Sim, died at Hove, Brighton, England on 26 September 1915. Her will, dated 9 April 1908, split her estate between her four eldest children. The will explained that her youngest son, Frederick William Sim, was to receive nothing as she had paid considerable sums for his debts since his father died.

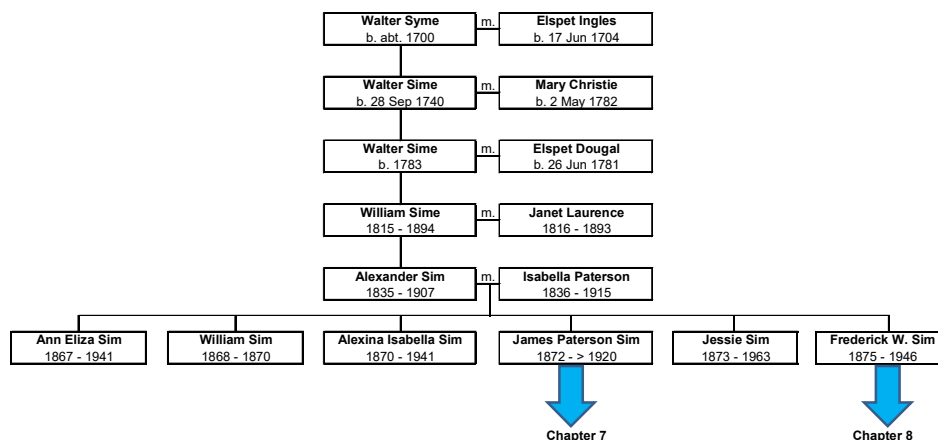

Chapter 4 – George Innes Sim

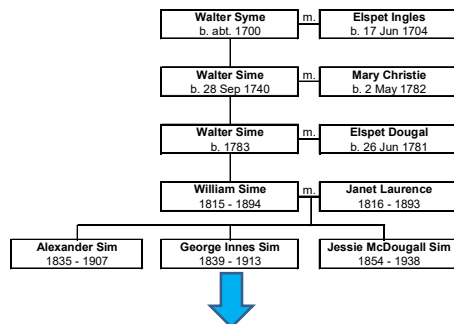

George Innes Sim, second child of William Sim and Janet Laurence, was born at Croftgloy, Deskford, on 21 June 1839. Like his older brother Alexander, George received a good education. He graduated from the University of Aberdeen with a M.A. in 1862 and from the University of Edinburgh in 1868 with a Bachelor of Divinity degree.

He married Margaret Chrystal of Aberdeen on 4 July 1865, and their marriage produced 5 children, as follows –

- John Robertson Sim, born 16 September 1869
- Jane Robertson Sim, born 23 March 1871
- Jessie Margaret Sim, born 21 October 1872
- Georgina Sim, born 21 October 1873
- Eliza Sim, born 29 November 1874

George became Schoolmaster at Rothiemay, Banffshire in 1862 and on 2 July 1867 he was licensed by the Presbytery of Strathbogie, and ordained to Glenlivet in 1872. In the 1881 census, George is found living at Drumoak, with his children and housekeeper, Catherine Goodlet (sic).

On 6 February 1883 he resigned his position at Drumoak and travelled to Australia, where he became Minister of the Presbyterian Church in Casterton, Victoria. Whilst still at Castertonⁱⁱ, on 4 June 1892, George petitioned for dissolution of his marriage, claiming desertion since April 1882. The petition described a controlling alcoholic mother in law, with undue influence over his wife, and how they had previously sought counselling, which resulted in his wife committing to staying away from her mother. George described how his wife's intemperate habits had impacted his reputation and his position within the church, prompting him to decide that the family should relocate to Australia to make a fresh start. He stated that his wife agreed to this plan, but then changed her mind, suggesting that she would join him once he had found suitable work and accommodation, so George and his four daughters departed on the Orient Line ship *Cuzco* in February 1882, leaving his son John in Scotland. Margaret responded to the petition, stating that she had left on account of George's cruelty and ill-treatment. The Judge issued a decree nisi, and the marriage was over.

Margaret Sim, nee Chrystal, died at Huntly, Aberdeenshire, on 6 April 1894. Her death certificate states that she died from chronic alcoholism and jaundice, which might lead the reader to believe George's version of their married life rather than Margaret's version. Just a

few months later, on 28 June 1894, George Innes Sim married Catherine Ollason Goodlet in New Zealand, where he was working as Rector of a high school in Rangiora. They later lived in Auckland, where George was Principal at Queen's College, a position he held from 1900-1903.

At some point after 1903, George and Catherine left New Zealand and returned to Australia, as the Victoria Police Gazetteⁱⁱⁱ of 26 November 1908 states that "*George Innes Sim is charged, on warrant, with deserting his wife, Catherine Sim, Portland, at Portland, on the 28th September last. Description: A school teacher, about 70 years of age, sallow complexion, active. – O.7130A. 18th November, 1908*". So perhaps George was not entirely without fault in the failure of his first marriage?

George Innes Sim died on the Isle of Wight, Hampshire, England on 11 January, 1913, aged 73 years. Catherine Sim, nee Goodlet, died in Portland, Victoria, Australia in 1937 at the age of 79 years.

John Robertson Sim, the eldest child and only son of George Sim and Margaret Chrystal will be covered in chapter 5.

On 23 March 1898, the eldest daughter and second child of George Innes Sim, Jane Robertson Sim, married Henderson Gow in St. Machar, Aberdeenshire. On the marriage registration Jane stated her residence as the North of Scotland Bank House in Cullen, Banffshire, so she was living in the household of her paternal uncle, Alexander Sim, at the time of her marriage. This couple do not appear to have had any children, certainly none who survived to adulthood, and Henderson Gow died at Bournemouth, England on 4 October 1928, aged 61 years. Jane Gow (nee Sim) died at Boscombe, Bournemouth on 2 October 1944, at 73 years of age.

Jessie Margaret Sim, the third child of George and Margaret, married Walter Whitehouse of Wellington, New Zealand, in Victoria, Australia in 1904, but soon after the couple moved to Wellington. Jessie Whitehouse (nee Sim) died childless on 21 January 1913 in Wellington at the age of 40 years, and is buried there in the Karori cemetery.

In 1916, Walter Whitehouse married Eliza Sim, his late wife's sister, and they continued to live in Wellington, where Walter worked as a Clerk. Walter's father, Thomas Whitehouse died in March 1913, leaving Walter a house plus a business property, so it is surprising that, citing financial difficulties, Walter was convicted of stealing from his employer in 1929. He was sentenced to two years in prison, which resulted in him declaring personal bankruptcy later that year. Walter Whitehouse died in 1951 and Eliza Whitehouse (nee Sim) died 14 July 1963 at Wellington.

Georgina Sim at some point after 1900 moved from New Zealand to England, and in the 1939 Register is found listed as a Nurse Companion, living with her widowed sister, Jane Gow, at Boscombe, Bournemouth. Georgina Sim died at Boscombe on 11 January 1964, unmarried and intestate, at 90 years of age, the last of the five children of George Innes Sim and Margaret Chrystal. A search for Georgina's heirs identified three sons of a cousin, who would have inherited her substantial estate, until a friend of her late sister, Eliza, in New Zealand, remembered that there was a brother in Scotland and notified the lawyers of this. The eight children of John Robertson Sim were subsequently found and they received their rightful inheritance^{iv}.

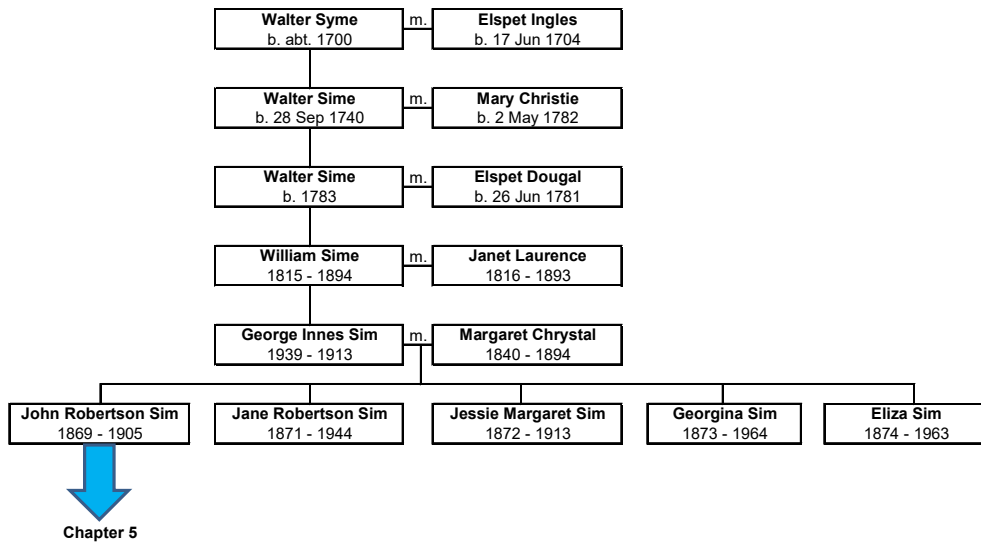

Chapter 5 – John Robertson Sim

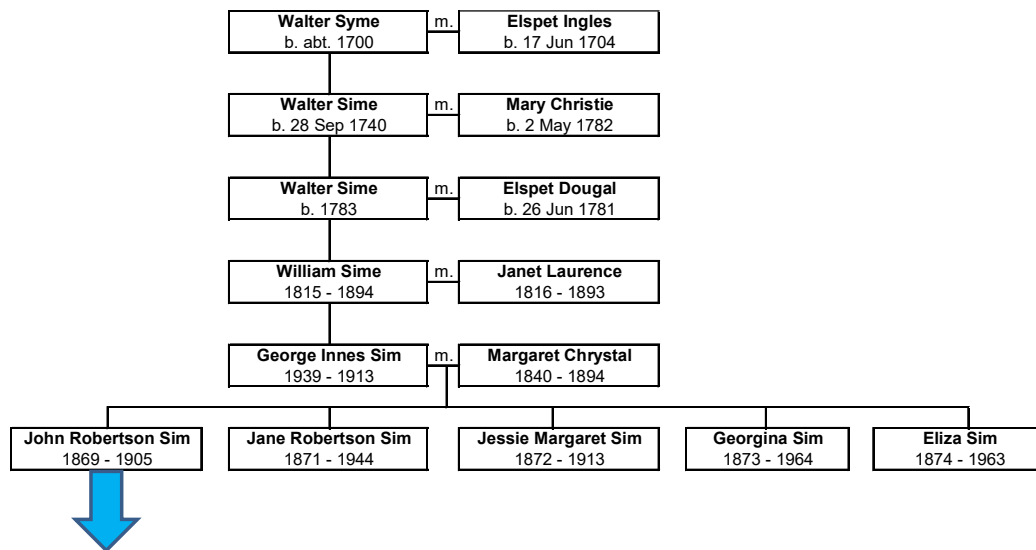

John Robertson Sim, the only son of George Innes Sim and Margaret Chrystal, is found in the 1891 census of Scotland, living with his mother in Huntly, Aberdeenshire. He is listed as “*living on private means*”. Information provided by one of his descendants is that he went on a world trip with his mother, and met Alice Theresa O’Grady in Sydney, Australia and married her there on 5 November 1891.

John’s grandfather, William Sim, made a new will in January 1891, whereby he left £10 to John and £25 to each of his sisters. However a codicil dated 27 February 1892 states that John is to receive nothing directly or indirectly from the estate of his grandfather, so he obviously fell out of favour with the Sim family, likely because he was living with his mother. William Sim died in December 1894, just eight months after John’s mother, Margaret Sim (nee Chrystal).

John and Alice lived well while John’s mother was alive, but after her death in 1894 John was forced to find employment. He tried many trades, but his niche was as a cook on ships. In the 1901 census he is found on board the vessel *Mayfield* at Tyne Docks, South Shields, Yorkshire, listed as a 31 year old cook.

Between 1892 and 1904, John and Alice Sim produced eight^v children (although I have been able to document only seven of them), born in various locations around Scotland, as follows –

- John Mearns Edward Sim, born 1892 at Huntly, Aberdeenshire
- David Christall Sim, born 1894 at Huntly, Aberdeenshire
- Alice Edith Sim, born 1895 at Huntly, Aberdeenshire
- George Innes Sim, born 23 April 1898 at Aberdeen, Aberdeenshire
- Alexander Sim, born circa 1901 at Dundee, Forfar
- Alfred Sim, born circa 1902 at Granton, Edinburgh
- Jane Robertson Sim, born 1904 at Aberdeen, Aberdeenshire

John Robertson Sim died 10 October 1905 at the East Poorhouse in Aberdeen, at the age of 36 years. The cause of death was a Tumour of the Brain. This left Alice to raise the eight children, aged 1 to 13 years old, on her own. In 1933, after her children were all adults, she married a

labourer named Robert Leggat, but sadly died just two years later, on 22 March 1935 at Elgin, Moray, at 73 years of age.

John Mearns Edward Sim, the eldest of the eight children, travelled to New Zealand, and married Rose Ann McTeigue in Christchurch on 4 May 1916. This marriage produced one child, Catherine Rosina Alice Sim in 1918, who married and had at least 7 children. The marriage of John Sim and Rose McTeigue seems to have broken down soon after the birth of their daughter Catherine. By 1925 Rose had had two children with James Frederick Booth, and John Sim disappears from New Zealand records after the 1928 electoral roll. Rose died in Taihape, New Zealand in 1932 and no further record has been found of John.

The second child, David Christall Sim, married Christine Copland Watt in Huntly, Aberdeenshire in 1918, but this family has not been researched further.

Alice Edith Sim emigrated to Manitoba, Canada and married William Grant in Winnipeg in 1924. By the time of the 1926 census, the couple had one son, James Grant, who was 11 months old. This family has not been researched further.

George Innes Sim, the fourth child, married Nellie Jane Morrison in St. Nicholas, Aberdeen on 9 August 1920, and the marriage produced four children as follows –

- Alice Edith Sim, born 25 July 1922 at Huntly, Aberdeenshire
- Alexina Sim, born 29 December 1924 at Huntly, Aberdeenshire
- George Innes Sim, born 1926 at Huntly, Aberdeenshire
- John Sim, born abt. 1928 in Scotland

Soon after the birth of their fourth child, George Innes Sim set off for Canada, with a plan to have his wife and children join him, once he had found suitable work. Whilst on the ship to Canada, George took ill with a recurrence of an old ailment, and was carried from the ship to a hospital on arrival in Quebec City. George was in the hospital for 3 months and then continued his journey overland to Winnipeg. He soon found work and sent for his wife and children, after which the family prospered for about three years. George took ill once again in early 1932 and died at St. Boniface, Manitoba on 24 April 1932. Just one year and seven months later, on 25 November 1933, Nellie died following a protracted battle with Bright's Disease, leaving the four children orphans. Nellie's parents insisted that the children be returned to them in Scotland, and in early 1934 the children, aged 5 to 11 years, travelled unaccompanied by train to Halifax, ship to Liverpool and train to Huntly, to be reunited with their grandparents^{vi}.

Nothing is known of the lives of Alexander and Alfred Sim, beyond their presence in the 1911 census of Rothiemay, Banffshire.

Jane Robertson Sim married Robert Farquhar in Huntly, Aberdeenshire, in 1923 and died at Elgin, Moray, in 1983.

There is still much research to be done on the descendants of John Robertson Sim, but the details found to date are as follows –

1. John Robertson SIM (b.16 Sep 1869-Rothiemay, Banff, Scotland; d.10 Oct 1905- St. Nicholas, Aberdeen, Scotland).

- sp: Alice T. O'GRADY (bapt. 15 Jan 1862-Banogue, Limerick, Ireland; m. 5 Nov 1891; d. 22 Mar 1935-Elgin, Moray, Scotland)
2. John Mearns Edward SIM (b. Abt 1892-Huntly, Aberdeen, Scotland; d. Aft 1920)
sp: Rose Ann MCTEIGUE (b. Abt 1895-Halswell, Canterbury, New Zealand; m.4 May 1916; d.1932-Taihape, New Zealand)
 3. Catherine Rosina Alice SIM (b.1918-New Zealand; d.1959-New Zealand)
sp: Arthur Stephen George REYNISH (b.10 Apr 1908-New Zealand; m.1935; d.1978- New Zealand)
 4. Paul Sylvester REYNISH (b.5 Jun 1936-New Zealand; d.28 Sep 1960-Tauranga, Bay of Plenty, New Zealand)
 4. Garry Stephen REYNISH (b.17 Sep 1938-New Zealand; d.21 Apr 1991-Christchurch, Canterbury, New Zealand)
sp: Maureen Anne ROGERS (b. Abt 1940-Christchurch, Canterbury, New Zealand; d.24 Feb 2021-Christchurch, Canterbury, New Zealand)
 4. Peter Maxwell REYNISH (b.7 May 1940-New Zealand; d. 4 Feb 2004-Nelson, Tasman, New Zealand)
sp: Janice Irene
 5. Craig Douglas REYNISH
 4. Warren REYNISH (b.22 Oct 1942-Nelson Bays, New Zealand; d.2007-Richmond, Christchurch, New Zealand)
sp: Carol Joan H. JONES (b. Abt 1946-Nelson Bays, New Zealand)
 5. female REYNISH (b.1964-Nelson Bays, New Zealand)
 5. male REYNISH (b.1968-Nelson,Nelson Bays, New Zealand)
 4. Adele REYNISH (b.25 Sep 1944-New Zealand)
 4. Brian REYNISH (b.12 Oct 1947-New Zealand)
 4. Ann REYNISH (b.5 Jan 1952-New Zealand)
 2. David Christall SIM (b.1894-Huntly, Aberdeen, Scotland; d.1959-Aberdeen, Scotland)
sp: Christine Copland WATT (m.1918)
 2. Alice Edith SIM (b. Abt 1895-Huntly, Aberdeen, Scotland; d.Aft 1910)
sp: William GRANT (m.1924)
 3. James GRANT (b. 1925-Manitoba, Canada)
 2. George Innes SIM (b.23 Apr 1898-Aberdeen, Aberdeen, Scotland; d.24 Apr 1932-St. Boniface, Manitoba, Canada)
sp: Nellie Jane MORRISON (b.7 Jun 1895-Huntly, Aberdeen, Scotland; m.9 Aug 1920; d.25 Nov 1933-St. Boniface, Manitoba, Canada)
 3. Alice Edith SIM (b.25 Jul 1922-Huntly, Aberdeen, Scotland; d.3 Dec 2000-Stoke Mandeville, Buckingham, England)
sp: James AITCHISON (b.25 Jun 1922-Hamilton, Lanark, Scotland; m.12 Sep 1947; d.8 Mar 2011-Amersham, Buckingham, England)
 3. Alexina SIM (b.29 Dec 1924-Huntly, Aberdeen, Scotland; d.18 Mar 1996-Wheeling, Cook, Illinois, United States of America)
 3. George Innes SIM (b.1926-Huntly, Aberdeen, Scotland; d.1982-Coburg, Victoria, Australia)
 2. Alexander SIM (b. Abt 1901-Dundee, Forfar, Scotland; d. Aft 1910)
 2. Alfred SIM (b. Abt 1902-Granton, Edinburgh, Scotland; d. Aft 1910)

2. Jane Robertson SIM (b.1904-Aberdeen, Aberdeen, Scotland; d.1983-Elgin, Moray, Scotland)

sp: Robert FARQUHAR (m.1923)

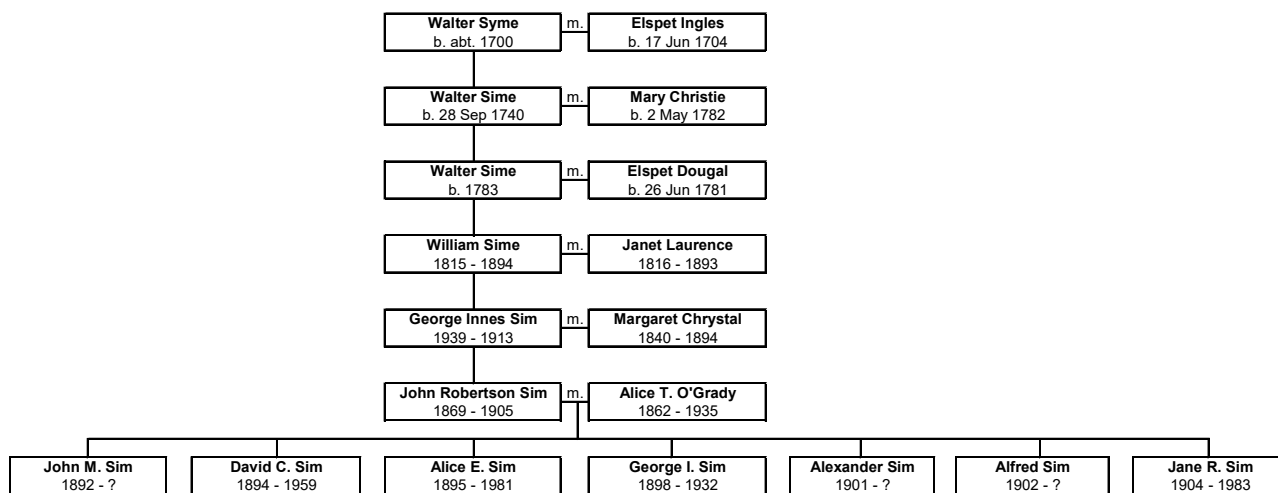

Chapter 6 – Jessie McDougall Sim

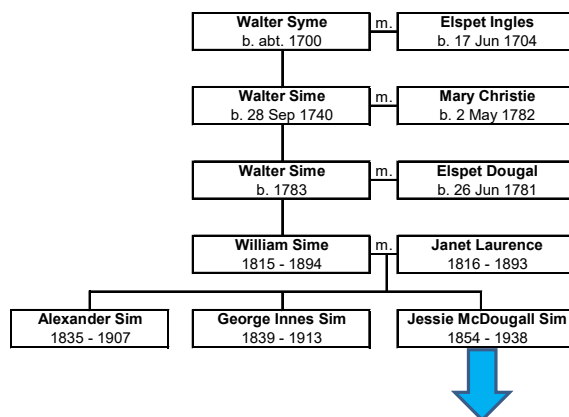

Jessie McDougall Sim, the third and youngest child of William Sim and Janet Laurence, was born at Croftgloy, Deskford, on 5 March 1854.

On 13 December 1877, at the residence of her brother, Alexander Sim, 23 year old Jessie married Alexander Thompson Garden, a 32 year old Farmer, residing at Deskford. Jessie and Alexander Garden raised a family of four children, as follows –

- William Sim Garden, born 1879
- Alexander Sim Garden, born 1880
- Jessie Florence Murray Garden, born 1888
- Murray Young Garden, born 1895

Jessie died as a child; William became a Doctor of Medicine and lived in England, where he married and raised two sons; Murray also became a Doctor of Medicine, married, and died in London, England at the age of 28 years; and I have found no trace of Alexander after the 1901 census.

Alexander Thompson Garden died in 1924 and his wife Jessie died in Portsoy, Banffshire on 4 May 1938, at the age of 83 years, from chronic bronchitis and cardiac failure.

The known descendants of Jessie and Alexander Garden are as follows -

1. Jessie McDougall SIM (b.5 Mar 1854-Croftgloy, Deskford, Banff, Scotland; d.4 May 1938-Portsoy, Banff, Scotland)
sp: Alexander Thompson GARDEN (b.21 Mar 1845-Deskford, Banff, Scotland; m.13 Dec 1877; d.1924-Elgin, Banff, Scotland)
2. William Sim GARDEN (b.6 Jun 1879-Deskford, Banff, Scotland; d.26 Nov 1952-Manchester, Lancashire, England)
sp: Jennie Barrie POSTLETHWAITE (b. Jul/Sep 1885-Leeds, York, England; m. Oct/Dec 1908; d. Jan/Mar 1919-Wakefield, York, England)
3. Richard Allistair Sim GARDEN (b.11 Oct 1910-Horbury, York, England; d.6 Aug 1978-Salford, Lancashire, England)
sp: Mary SMITH (b.27 Apr 1912; m. Apr/Jun 1934; d.3 Jun 1970-Salford, Lancashire, England)

3. Ian Seaforth GARDEN (b. Jan/Mar 1915-Wakefield, York, England; d.1976-Durban, Natal, South Africa)

sp: Marjorie Florence Julia THORNE (b. Abt 1913-South Africa; m.27 Nov 1937)

sp: Joan Dorothy Gloria RAYNE (b.1922-South Africa; m.9 Sep 1944; d.1984-South Africa)

4. Jennifer GARDEN

sp: VAN ROOYEN

sp: Mary Priscilla VENO (b.14 Nov 1898-Chorlton,Lancashire,England;m.27 Aug 1929;d.12 Jul 1980- Macclesfield, Cheshire, England)

2. Alexander Sim GARDEN (b.1880-Deskford, Banff, Scotland; d. Aft 1900)

2. Jessie Florence Murray GARDEN (b.1888-Fordyce, Banff, Scotland; d.1 Nov 1894-Brankanentham, Fordyce, Banff, Scotland)

2. Murray Young GARDEN (b.1895-Fordyce, Banff, Scotland; d. Apr/Jun 1924-Chelsea, London, England)

sp: Elizabeth Ellen B. FLAVIN (b. Jan/Mar 1898-Ashton under Lyme, Lancashire, England; m. Jul/Sep 1923; d. Apr/Jun 1926-Kensington, London, England)

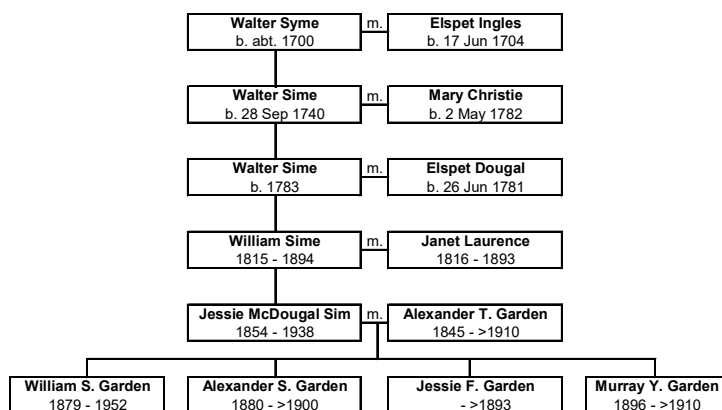

Chapter 7 – James Paterson Sim

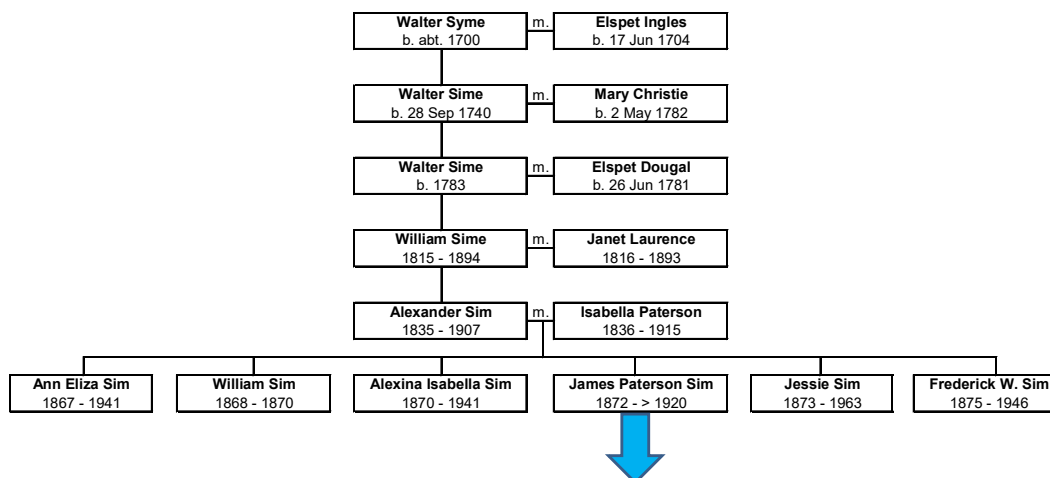

James Paterson Sim was born in Cullen, Banffshire, Scotland, the fourth child and eldest surviving son of Alexander Sim and Isabella Bartlet Paterson. In the 1891 census, he is found living with his parents and is listed as a 19 year old Bank Apprentice, but soon afterwards he emigrated to British Columbia, Canada.

On 25 April 1893, 21 year old Rancher, James Paterson Sim, married 18 year old Amy Augusta Robinson in New Westminster, British Columbia. Amy was living in New Westminster at the time of the marriage, but she was born in Victoria, British Columbia. This marriage produced six children as follows –

- James Alexander Sim, born 15 August 1894
- Amy Isobel Sim, born 29 August 1896
- Elbridge Robinson Sim, born 21 December 1898
- Leonard Frank Sim, born 13 March 1903
- Clifford Frederick Sim, born 21 July 1907
- Janet Kathleen Sim, born 30 April 1911.

James Paterson Sim attested three times for service in World War I, but as he was well into his 40s I don't believe he served on active duty on any of these occasions. At some point after this, James P. Sim left his family in British Columbia and moved to Red Deer Alberta,

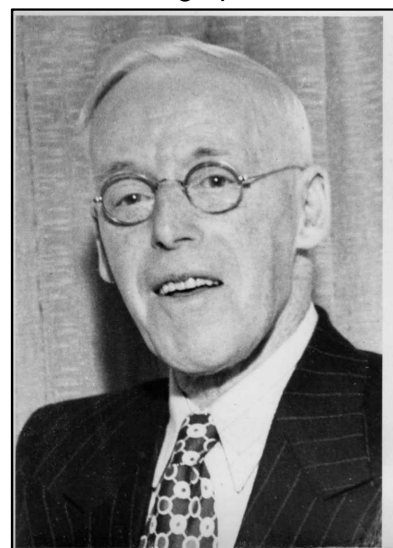

James Paterson Sim

He appears in the 1921 census of Alberta, living at Red Deer, with a new wife, Margaret, and son, Hugh Sim. Hugh was actually a son of Margaret and her former partner, Gilbert Victor Orange, and he was born in Quebec circa 1915. James Paterson Sim and Margaret (Aitchison) did have one child together, James Sim, born circa 1922. Children Hugh and James are found living with their mother Margaret in the 1926 census of Red Deer, but James Paterson Sim is not listed with them.

The book "*Olds: a history of Olds and area*"^{vii} has the following to say about James Paterson Sim - "*Jim Sim, as he was generally known, was an interesting if not altogether admirable character, who came to the Coburn district in 1919. He settled on a quarter section, five and a half miles south of the cloverleaf. His eldest son, Bob, came with him and settled on another Soldier Settlement Board farm about a mile and a half northeast of Jim. The remainder of his first family of seven children lived at the coast with their mother. Soon after Jim and Bob arrived, a young woman with a small boy came from England to set up house-keeping with Jim. A son was born to them a few years later. Jim was a charming Scot. He claimed to be the son of a wealthy Scottish banker. He was an able conversationalist and always had interesting stories to tell. He had an unslakeable thirst and made many trips to Olds and Didsbury to get prescriptions filled during prohibition. After beer parlours were opened, he didn't always get home at night and out of concern for the welfare of his cows, neighbors came to the rescue by milking them.*"

The story continues, talking of how Jim's charm and convincing manner made it possible for him to get into debt, and once he reached the end of his financial tether he sold off the farm equipment (which belonged to the Soldier Settlement Board), borrowed more money, and his son put him on the train at Carstairs. He was supposedly seen somewhere in Saskatchewan at a later date. He had abandoned another wife and family and disappeared. I believe that he was still living at the time of his brother Frederick's death in 1946, as the newspaper death notice identified that Frederick Sim was survived by a brother.

Amy Augusta, first wife of James Paterson Sim, died of cancer in Esquimalt, British Columbia on 1 April 1944 at the age of 69 years. James' second wife, Margaret, died in Calgary, Alberta in 1956 at the age of 65 years.

The known descendants of James Paterson Sim, from his two marriages, are as follows –

1. James Paterson SIM (b.11 Mar 1872-Cullen, Banff, Scotland; d. Aft 1945)
sp: Amy Augusta ROBINSON (b.17 Jun 1875-Victoria, British Columbia, Canada; m.25 Apr 1893; d. 1 Apr 1944-Esquimalt, B.C., Canada)
 2. James Alexander SIM (b.15 Aug 1894-Abbotsford, British Columbia, Canada; d.Aft 1900)
 2. Amy Isobel SIM (b.29 Aug 1896-Abbotsford, British Columbia, Canada; d.22 Jun 1973-Saanich, British Columbia, Canada)
sp: Wilfred MATTHEWS (b.10 Sep 1895-Calgary, Alberta, Canada; m.23 Aug 1913; d.3 Feb 1963-Victoria, British Columbia, Canada)
 3. Thomas Wilfred MATTHEWS (b.24 Jan 1917-Victoria, British Columbia, Canada; d.12 Jan 1995-Victoria, British Columbia, Canada)
sp: Helen Christina MACKAY (b. Abt 1913-Swift Current, Saskatchewan, Canada; m.30 Sep 1942)
 3. Edward MATTHEWS (b. Abt 1916-British Columbia, Canada; d. Aft 1920)
 3. Cecil MATTHEWS (b. Abt 1917-British Columbia, Canada; d. Aft 1920)
2. Elbridge Robinson SIM (b.21 Dec 1898-Abbotsford, British Columbia, Canada; d.2 Mar 1975-Victoria, British Columbia, Canada)
sp: Isabel Severina HANSON (b.24 Aug 1900-Minnesota, United States of America; d.17 Oct 1976-Victoria, B.C., Canada)
 3. Robin Alexander SIM (b. Abt 1931-North Battleford, Saskatchewan, Canada; d.10 Jun 1944-Victoria, British Columbia, Canada)

3. Jean Emily SIM (b.1 Mar 1935-Battleford, Saskatchewan, Canada; d.3 May 1989-Vancouver, British Columbia, Canada)
 sp: Fulton Stephen PREST (b.30 Apr 1936-Grosse Isle, Quebec, Canada; m.1 Oct 1960; d.24 Jun 2000-Victoria, B.C., Canada)
 4. Margaret PREST
 4. Robin PREST
3. Janet Kathleen SIM (b. 23 May 1937-North Battleford, Saskatchewan, Canada; d. 21 Jul 2013 – Victoria, British Columbia, Canada)
 sp: Roy JONES (m. 8 May 1959)
 4. Roy Kenneth JONES (b. 9 Sep 1959-Fort Churchill, Manitoba, Canada; d. 22 Oct 2008-St. Albert, Alberta, Canada)
 4. living JONES
 4. living JONES
3. Amy Isabel SIM (d. 2010-Coquitlam, British Columbia, Canada)
 sp: Harry Frederick (Jim) HOCKEY (b. 12 Sep 1921-Calgary, Alberta, Canada; d. 29 Apr 1990-Coquitlam, British Columbia, Canada)
 4. living HOCKEY
 4. Richard Stephen HOCKEY (b. 13 May 1950-Victoria, British Columbia, Canada; d. 1 Dec 1995-New Westminster, British Columbia, Canada)



Elbridge and Isabel Sim with daughters Amy, Jean and Janet.

2. Leonard Frank SIM (b.13 Mar 1903-Abbotsford, British Columbia, Canada; d.25 Feb 1984-Victoria, British Columbia, Canada)
 sp: Nellie May BETTS (b.2 May 1904-Stony Stratford, Buckingham, England; m.12 Mar 1924; d.24 Dec 1995-Victoria, B.C., Canada)
2. Clifford Frederick SIM (b.21 Jul 1907-Abbotsford, British Columbia, Canada; d.3 Apr 1987-Victoria, British Columbia, Canada)
 sp: Doris Ann BONIFACE (b. Abt 1914-Victoria, British Columbia, Canada; m.18 Nov 1939; d. Aft 1986)
2. Janet Kathleen SIM (b.30 Apr 1911-Abbotsford, British Columbia, Canada; d.15 Oct 1991-Victoria, British Columbia, Canada)
 sp: William John ENGLISH (b. Jul/Sep 1901-England; m.8 Aug 1928(Div); d. 16 Mar 2003-

Duncan, British Columbia, Canada)

sp: Paul BARTEL (d. Bef 1992)

sp: Margaret AITCHISON (b.1891-Bridgeton, Lanark, Scotland; m.8 Oct 1920 – Calgary, Alberta, Canada; d.1956-Calgary, Alberta, Canada)

2. James SIM (b. Abt 1922-Alberta, Canada)

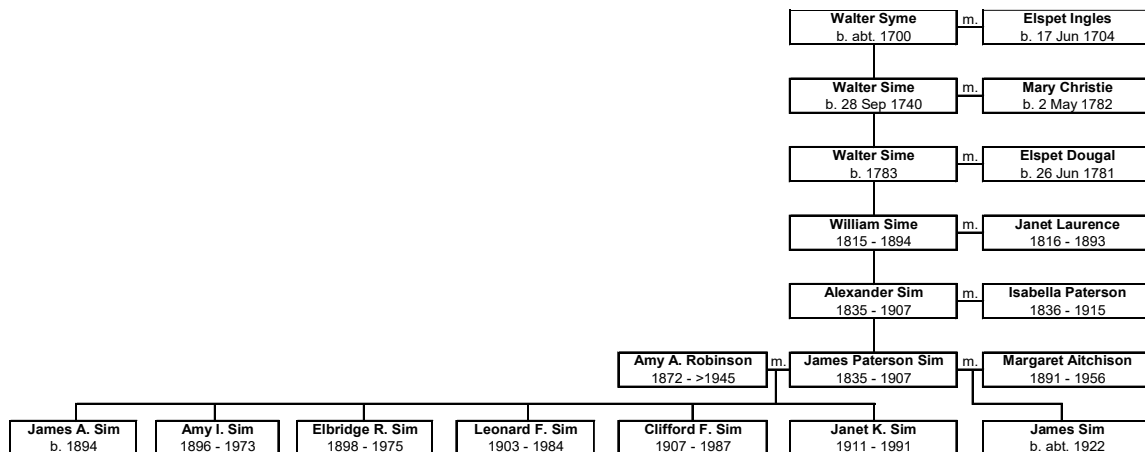

Chapter 8 – Frederick William Sim (1875 – 1946)

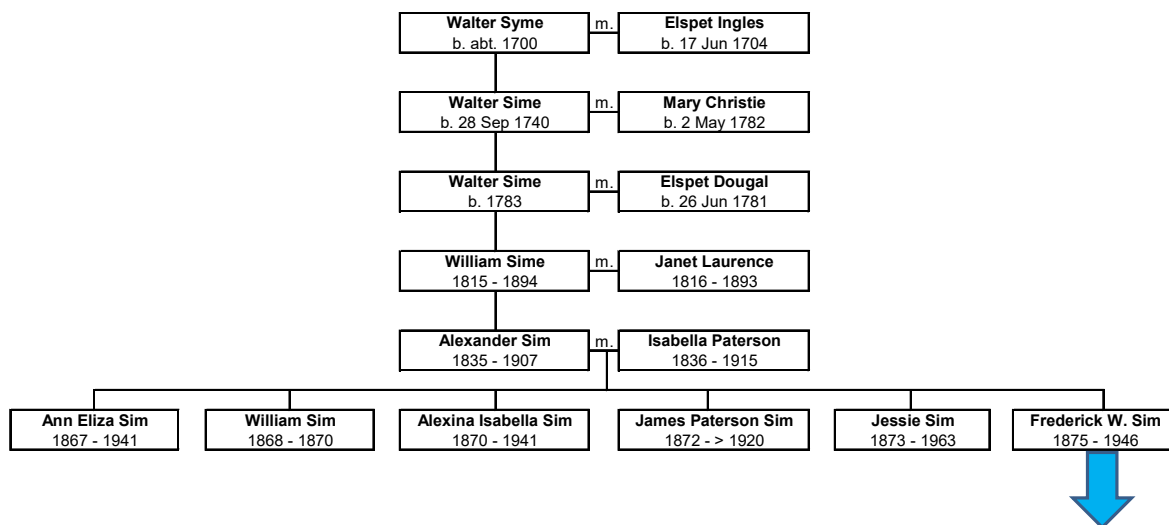

Frederick William Sim was born in Cullen, Banffshire on 13 September 1875, the youngest child of Alexander Sim and Isabella Bartlet Paterson.

Young Fred was six feet three inches tall, served as a Captain in the 1st Banff Volunteer Artillery, and farmed at Croftgloy, although an article titled *Recalling some of the people of Cullen abt. 1900*, found in the Cullen Heritage files at the Buckie Public Library, suggested that he preferred the town, and had stables at the south end of Reidhaven Street. The 1901 census refers to Fred as a 25 year old Law Clerk, so he appears to have initially followed in the footsteps of his father.

Alexander Sim's will dated 21 May 1906, states that he has made considerable advances to his sons James Paterson Sim and Frederick William Sim, and that Frederick is entering into a lease on the Farm of Maryhill in the Parish of Rathven on Whitsunday (3 June 1906).

Frederick employed Isabella Moir McIntosh, daughter of Charles McIntosh of Newlands Lane, Buckie, as his housekeeper at Maryhill Farm, and Isabella became pregnant soon after. When her son was born at Mid Street, Keith, on 7 March 1907, Isabella named him James Stuart McIntosh, and on the birth registration, the father's name is blank.

This illegitimate birth would have caused some angst in Isabella's family, and as Alexander Sim had died the previous January, Isabella's father, Charles McIntosh, must have had discussions with Alexander's widow, about Fred taking responsibility for the child, as on 2 June 1908, Fred and Isabella were quietly married in Aberdeen, by order of the Sheriff, before being shipped off to Canada on the S.S. *Grampian*, which sailed from Glasgow on 6 June, headed to Montreal. It appears that Fred and family did not sail on the S.S. *Grampian* as planned, instead sailing first class on the S.S. *Pretorian*, which left Glasgow on 5 September. In the meantime, Fred was declared bankrupt^{viii}.

When Fred's mother made her will on 9 April 1908, she left nothing to Fred, and the will states "...I would here state that the reason why I have not included my Son Frederick William Sim as participating in my Estate is that I have since his Father's death had to pay for him considerable sums for which I became security for him on Bills...".

A story passed down in one branch of the family is that Fred and Isabella lived in the Royal York Hotel in Toronto for two years after arriving in Canada, which must have been a challenge, given that Fred had declared bankruptcy in Scotland, so perhaps his mother was footing the bill?

Regardless, reality eventually set in and Fred moved his family west to Saskatchewan in 1910, taking a position as a Police Constable with the Saskatchewan Provincial Police.

Whilst living in Saskatchewan, Fred and Isabella had five additional children, as follows –

- Jessie Sim, born 1 September 1910
- Charles Alexander Sim, born 21 October 1911
- MacIntosh Sim, born 3 August 1916
- Norman Bartlett Patterson Sim, born 11 June 1922
- Audrey Jean Sim, born 7 October 1926



Frederick William Sim (senior).

Fred also worked at the Prince Albert Correctional Institution, the Carlton Indian Reserve and the Weyburn Mental Institution, but in 1929, he moved his family to Red Deer, Alberta, where Fred was employed by the city police force for a number of years. He died in Red Deer on 4 July 1946 after a long illness, and is buried in the Red Deer Cemetery.

The first son of Fred and Isabella, born as James Stuart McIntosh, was raised as Frederick William Sim junior. As he approached retirement age, Fred junior asked his mother if she had a copy of his birth certificate. She replied that they could not get a copy of his birth certificate, as the church where he was baptised had burned down. However, Isabella wrote to the General Register Office in Scotland and amended Fred's birth record, changing the name on the registration record from James Stuart McIntosh to Frederick William Sim.

Another story passed down in the family, is that if Isabella needed a new dress for an event, Fred would order five dresses from the Sears Catalog. Isabella would choose the one that she wanted to wear to the event, and after the event Fred would return all five to Sears.

Isabella Moir Sim, nee McIntosh, died at the University Hospital in Edmonton, Alberta, on 28 April 1971, aged 86 years. She is buried in the Red Deer Cemetery alongside her late husband.

Frederick William Sim junior will be covered in detail in the next chapter. The other known descendants of Frederick and Isabella Sim are as follows –

1. Frederick William SIM (b.13 Sep 1875-Cullen, Banff, Scotland; d.4 Jul 1946-Red Deer, Alberta, Canada)
 - sp: Isabella Moir MCINTOSH (b.28 May 1884-Knorrhead, Rathven, Banff, Scotland; m.2 Jun 1908; d.28 Apr 1971-Edmonton, Alberta, Canada)
2. Frederick William SIM – see Chapter 7.
2. Jessie SIM (b.1 Sep 1910-Weyburn, Saskatchewan, Canada; d.25 Dec 2007-Edmonton, Alberta, Canada)
 - sp: Ernest William HILLING (b. Abt 1911-Alberta, Canada; m.1941; d.26 Aug 1974-Edmonton, Alberta, Canada)
3. Bonnie HILLING (d. Jan/Feb 1992)
 - sp: Norman NELSON (m.(Div))
 4. Mikeiko NELSON
 4. Jeffery NELSON
 - sp: Barry SCHLOSS
 4. Daniel SCHLOSS
 4. Gillian SCHLOSS
3. James M. HILLING
 - sp: UNKNOWN
 4. male HILLING
 4. David HILLING
2. Charles Alexander SIM (b.21 Oct 1911-Saskatchewan,Canada;d.2002)
 - sp: Annie Duff MCCRACKEN (b.27 Oct 1913-Calgary, Alberta, Canada; m.1931(Div); d.10 Mar 2001-Calgary, Alberta, Canada)
3. Charles James SIM (b.18 Feb 1932)
 - pt: UNKNOWN
 4. Tod C.
 - sp: Melba Mary Frances JACOBSON (b. Abt 1934; m. Abt 1952; d.4 Jan 2004-Salmon Arm, British Columbia, Canada)
 4. Danny SIM
 - sp: Debbie
 4. John SIM
 - sp: Barb
 4. James SIM
 - sp: Darlene
 4. Diane SIM
 - sp: Terry MCFAUL
 4. Heather SIM
 - sp: Joe BURNETT
 4. Fay SIM
 - sp: Dale BRITTON
 - sp: Ainslie RANSOM (b. Abt 1921-Manitoba, Canada; m.4 Aug 1947; d.2007)
3. Jeffrey SIM
 - sp: Diane STURGEON
 4. Nathan Alexander SIM
2. Macintosh SIM (b.3 Aug 1916-Saskatchewan, Canada; d.31 Dec 2000-Red Deer, Alberta, Canada)

- sp: Janet MILNE (b. Abt 1923-Alberta, Canada)
3. Wayne Alexander SIM
 3. Wendy Marie SIM
- sp: Raymond BRECKNER
4. Natalie Rochelle BRECKNER (b.-Richmond, British Columbia, Canada)
3. Linda Gay SIM (b.-Red Deer, Alberta, Canada)
- sp: Chuck HAINES
2. Norman Bartlett Patterson SIM (b.11 Jun 1922-Carleton, Saskatchewan, Canada; d.3 May 2002-Nanaimo, British Columbia, Canada)
- sp: Mildred Vera (b.13 Jun 1922-Innisfail, Alberta, Canada; m. Abt 1948; d.12 Mar 2003-Nanaimo, British Columbia, Canada)
2. Audrey Jean SIM (b.7 Oct 1926; d.21 Feb 2017-St. Albert, Alberta, Canada)
- sp: Garth L.W. GREENAWAY
3. Carol Ann GREENAWAY
 3. Kathleen GREENAWAY

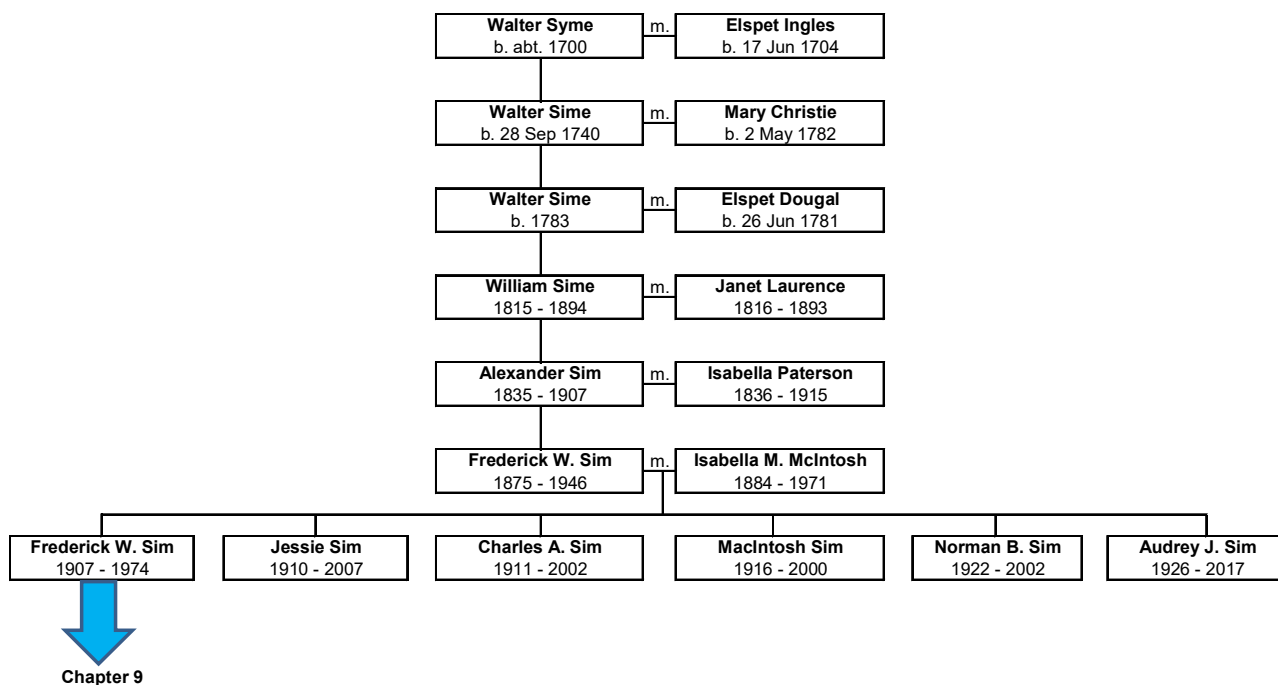

Chapter 9 – Frederick William Sim (1907 – 1974)

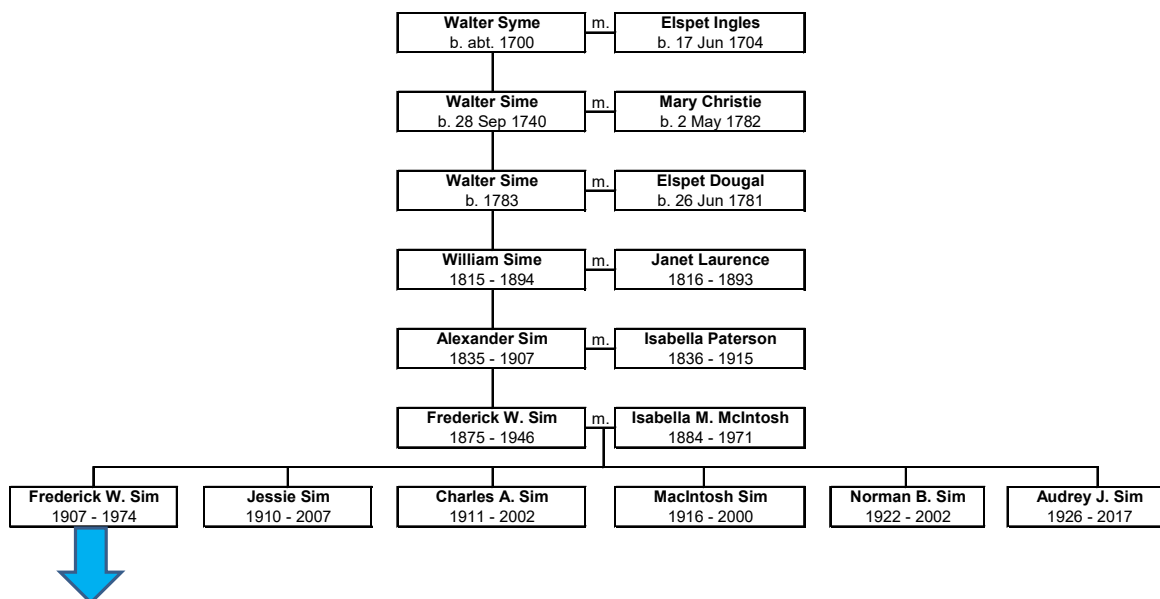

Frederick William Sim junior was born 7 March 1907 at 177a Mid Street, Keith, Banffshire, Scotland, the only child of Fred and Isabella Sim to be born in Scotland, before their emigration to Canada in 1908. As he was born prior to his parents' marriage, his birth name was registered as James Stuart McIntosh, but the record was later amended to change his name to Frederick William Sim, the name that he was known by throughout his life.

After leaving high school, Fred joined Canadian National Railways as a Labourer and was posted to Warman, Saskatchewan. It was here that he met Elsie Rosa Woods, daughter of the local C.N. Station Master, Ernest Charles Woods. Elsie became pregnant and the parents whisked them off to Saskatoon, where they were married on 3 July 1929, by the local Presbyterian Minister, with Fred's mother and Elsie's father as witnesses.

Fred was soon transferred to Forgan, Saskatchewan, followed by Birtle, Manitoba, and about 1937 he was transferred to Loverna, Saskatchewan. Fred and Elsie had nine children, all born in Forgan and Loverna, Saskatchewan, except for Audrey, as follows –

- Rosa Isabella Sim, born 31 January, 1930
- Neil MacIntosh Sim, born 21 August, 1932
- Fredda Iris Sim
- Audrey Sim, born 1935 at Birtle, Manitoba
- Russella Jean Sim, born 27 May 1936
- Shirley Ann-Hope Sim, born 1937
- Bruce Fraser Sim
- Barry Stuart Sim
- Richard William Winston Sim, born abt. 1943



Frederick W. Sim (junior).

The family was only in Birtle, Manitoba for a short time, but it was here that the fourth child, Audrey, was born in 1935, and sadly died three months later from pneumonia. So they were probably relieved to be transferred to Loverna, and put the tragedy behind them.

Life in Loverna was good for the Sim family. Fred was always working at something, whether at CN or at home, where they had large gardens, and he also found time to cut the hair of some of the local men, and to make and maintain outdoor ice rinks for the town children in the winter. In 1945 he was elected to the position of Mayor of Loverna.

Tragedy struck in 1950, when their thirteen year old daughter Shirley, died of leukemia. This put a huge strain on Fred and Elsie, from which their relationship did not recover. By 1958, Fred was living in Saskatoon, working as a maintenance foreman at the National Research Council, and in 1967 they officially divorced.

Frederick William Sim died in Saskatoon on 30 July 1974, at 67 years of age.

Elsie initially remained in Loverna with the younger children, but after the house burned down, she moved into town and found work at the Canadian Forces base in Alsask.

After her divorce from Fred, Elsie Sim married Gordon Scott (Pat) Aasen and the couple lived at Alsask. Pat died 14 December 1996 and Elsie died 18 July 2000.



Shirley Sim.



Rosa Sim & Tom McFee wedding.

Rosa Isabella, the eldest child of Fred and Elsie Sim married twice, firstly to Tom McFee in 1951, but the marriage ended in divorce, and Rosa later married Clifford Hogberg.

Rosa was an excellent curler, and won many tournaments. She did not have any children from either marriage and died in Edmonton, Alberta on 5 April 1985.

Neil MacIntosh Sim joined the Royal Canadian Air Force and rose to the rank of Warrant Officer. He married Bernadette Boyer in North Bay, Ontario on 3 July 1965, but they did not have any children together. Neil died at Ottawa General Hospital on 2 August 1998.



Neil Sim.



**Fredda Sim & Gerry Spriggs
1953 wedding.**

Fredda Iris Sim was working in Rosetown, Saskatchewan when she met Gerald Arthur (Gerry) Spriggs and they married in Rosetown in 1953, as Gerry was in the process of being transferred to Foam Lake, Saskatchewan. They moved to Foam Lake the following week, and it was there that their daughter Marlene Lynn (my wife), and son, Arthur William, were born, before Gerry was transferred to Regina (1957), Montreal (1965), Calgary (1966), Montreal (1969), Toronto (1976) and Winnipeg (1982). Their third child, Robert Gerald, was born in Montreal. After retirement, Gerry and Fredda relocated to Cloverdale, British Columbia, to enjoy the coastal climate. But Gerry's golden years were cut short and he died in 1989 at his daughter's house in Calgary, Alberta, and he is buried there in the Queen's Park cemetery.

Through a mutual friend, Fredda met Nicholas (Nick) Karbonik, a widower with three adult children, living in Calgary, and they married in Calgary on 8 February 1992. Fredda and Nick soon moved to Nanaimo, British Columbia, where they lived an active retirement, playing a lot of golf and travelling. Nick passed away suddenly in Nanaimo on 17 August 2018, and Fredda continues to live in Nanaimo.



Floyd Sonmor and Jean Sim wedding.

Russella Jean (Jean) Sim married local Loverna lad, Floyd Sonmor and they had two children – a son who lives in Kindersley and a daughter who lives on Vancouver Island.

Floyd Sonmor died on 1 November 1977 and is buried in Loverna's Mount Pleasant Cemetery. Jean moved to Edmonton, Alberta and worked there for many years as a Nurse. She died in Edmonton on 20 September 2016.



Bruce Sim and Donna Doig wedding.

Bruce Fraser Sim became a School Teacher and later a Corporate Lawyer. He married Donna Shirley Doig in Saskatoon on 4 July 1964. Bruce and Donna raised three children in Calgary, all of whom now live in the United States.

Barry Stuart Sim married Jean and they have three children, a son and two daughters.

Richard William Winston Sim received Winston as a given name as his father was a big fan of Winston Churchill, who was leading Britain in WWII at the time of Richard's birth. Richard was found dead below a bridge on the frozen North Saskatchewan River in February 1970. He had been paid the day before, and the family believe that he was likely mugged and thrown off the bridge.

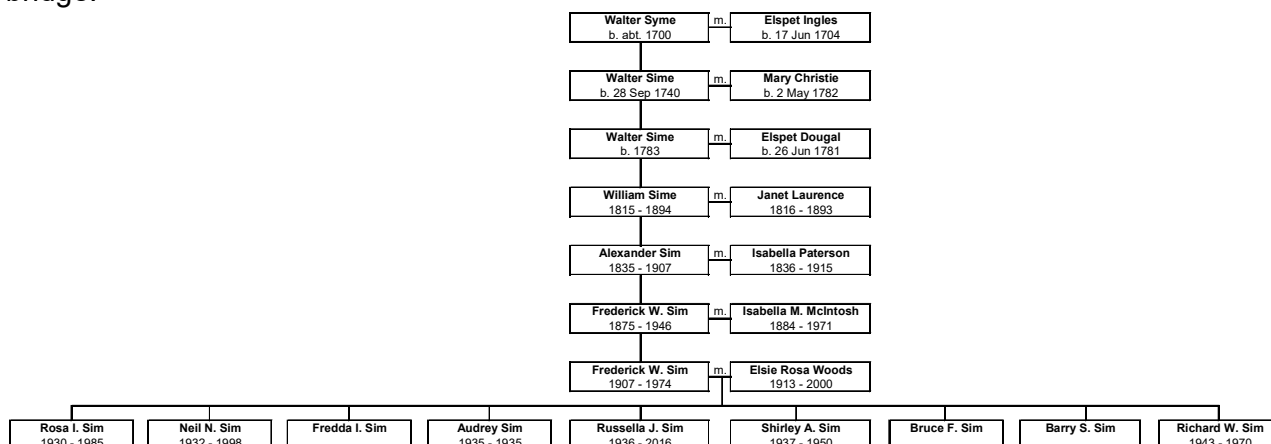

Chapter 10 – DNA Testing

The foregoing chapters have identified many of the descendants of Walter Sime, born circa 1700 in Banffshire, based primarily on public records. So it would be nice to be able to confirm the validity of the ancestral lines as researched, especially to confirm the parentage of Frederick William Sim (1907-1974), as his birth was originally registered as James Stuart McIntosh.

Autosomal DNA testing, through companies such as Ancestry, 23andMe, My Heritage and FamilyTreeDNA, is of huge benefit to genealogists in confirming familial connections identified by researching the paper trail of our ancestors. If two people who have well-researched family trees, which identify a common ancestor, also share autosomal DNA, and if there is no other obvious ancestral connection, then it is highly likely that the identified common ancestor is correct.

Through comparison of the autosomal DNA results of my mother in law, Fredda Iris Sim, with the results of others who have taken DNA tests (DNA matches), I have found several Sim cousins who were previously unknown to me, including descendants of two of the children of Walter Sime and Mary Christie. So autosomal DNA testing has been instrumental in confirming my wife's Sim ancestry. Identification of shared DNA between Fredda Sim and Sim line relatives at the first, second, third and fifth cousin levels confirms that Frederick William Sim (1875-1946) was the father of Frederick William Sim (1907-1974).

The chart below shows several of Fredda's Sim connections confirmed with autosomal DNA testing, but not all known DNA connections have been included in the chart to improve readability.

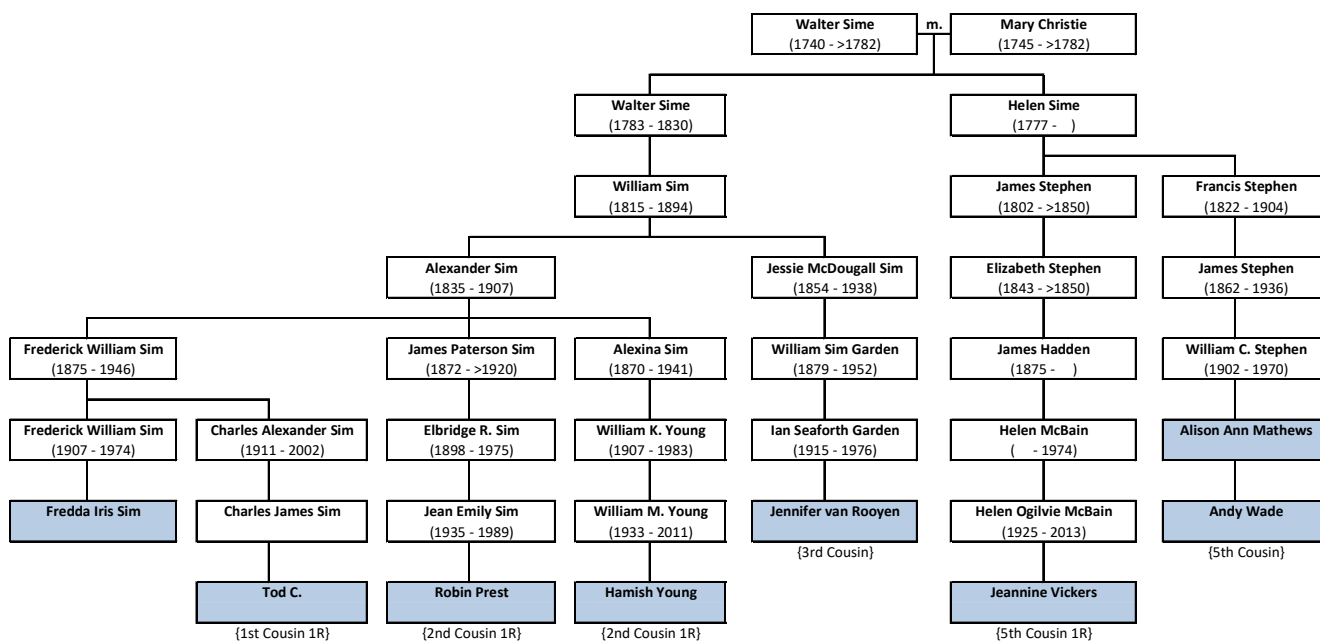

Sim DNA Connections of Fredda Iris Sim.

There are many other people who have taken autosomal DNA tests, with whom Fredda shares significant amounts of DNA, and with whom it appears that she may share a common Sim ancestor, but unfortunately there is no paper trail to establish the correct relationship.

It is unlikely that relatives beyond fifth cousins will share significant amounts of autosomal DNA, so for more distant connections on the male ancestral line, Y-DNA testing could also be very useful.

The Y-chromosome is passed down the male line from father to son, largely unchanged, although mutations do occur from time to time. It is these mutations that create what is termed “genetic distance” between Y-DNA samples – the genetic distance between two samples increases by 1 with each mutation on either line of descent from a common ancestor. The relative stability of the Y-chromosome is therefore useful in identifying common male ancestors in ancient times.

I therefore encourage male Sim descendants to take the Big Y-700 test at FamilyTreeDNA, or even the somewhat cheaper Y-111 test, which could help to clarify how our Sim family fits into the overall haplotree of humankind. These tests are frequently on sale, especially around Black Friday in November.

To date I am not aware of any Banffshire Sim male descendants who have taken Y-DNA tests, so even one person testing would be useful, and several, from different lines of descent would be a bonus.

References

ⁱ Banff Advertiser newspaper, 10 January 1907

ⁱⁱ The Sydney Morning Herald newspaper, 4 June 1892, page 9

ⁱⁱⁱ Victoria Police Gazette, 26 November 1908, page 453, column 2

^{iv} The Sim Saga; notes written by Alfred Sim, son of John Robertson Sim and provided to the author by his niece, Valerie Moore.

^v Sim notes written by Alfred Sim, son of John Robertson Sim, state that his mother raised eight of them.

^{vi} Newspaper cutting titled "Huntly Orphans' 4000 Mile Journey"; newspaper unknown; copy provided by Valerie Moore

^{vii} Olds: a history of Olds and area, Olds History Committee, 1980; ISBN 889251460; p.p.517-518

^{viii} Aberdeen Daily Journal, 4 July 1908, page 7